



CITY OF MESA APPROVED PRODUCTS LIST – WATER

APPROVED PRODUCTS LIST INDEX

- W-1 General Notes and Requirements
- W-2 Fire Hydrants
- W-3 Mechanical Joint Restraints for Ductile Iron Pipe
- W-4 Gate Valves & Appurtenances
- W-5 Combination Air Valves
- W-6 Tapping Sleeves
- W-7 Approved Wet Tap Contractors
- W-8 Underground Service Line Valves and Fittings
- W-9 Ductile Iron Compact Fittings - Mechanical Joint
- W-10 Ductile Iron Full Body Fittings - Mechanical Joint
- W-11 Ductile Iron Fittings – Unrestrained Push On Type
- W-12 Ductile Iron Fittings - Flanged
- W-13 Ductile Iron Pipe - Centrifugally Cast
- W-14 Integral Wedge-Type Locking Gaskets for Ductile Iron Pipe with Push-on Joints
- W-15 Joint Restraints for Ductile Iron Pipe with Push-On Joints
- W-16 Bolted Sleeve-Type Couplings for Plain End Pipe
- W-17 Full-Encirclement Repair Clamps for Water Service
- W-18 Bell Joint Leak Clamps for Water Service
- W-19 Insertion Valves
- W-20 Water Meter Assembly Appurtenances
- W-21 Corrosion Protection Systems for Ductile Iron Pipe
- W-22 Water Main Casing Appurtenances

Note: This products list encompasses 2023 Quarter 3 revisions and is applicable beginning 2023-10-05.

Created: 2/17/12
Revised: 10/05/23

INDEX - APPROVED PRODUCTS LIST

W-0



CITY OF MESA APPROVED PRODUCTS LIST – WATER

Overview:

The City of Mesa (City) has established procedures for the review and approval of products and select services utilized in the public water system. All products considered for use in the water system must be reviewed and approved by the Water Product and Design Review Committee (PDRC) prior to being included in the Approved Product List (APL).

Through previous investigation, usage by the City, and industry performance history, certain types, brands and models of products and materials have established a satisfactory in-service reliability record. These products have been tabulated by manufacturer's names and identifying numbers on the APL.

Select Service Contractor Approvals:

Service contractor approvals shall be submitted per the specific listed requirements on the relevant APL sheet. Submittals shall be formatted and transmitted to the City per the New Product and Select Service Contractor Submittal Details section on page 3.

The primary focus of the APL is products, not services. Therefore, services not currently provided under the APL will not be considered for inclusion as a new service, sheet, or specification.

Use by Design Engineers:

The APL includes products that meet the needs of most water utility construction projects within the City. Design engineers must, however, confirm that products in the APL meet their project needs. If the project requires products of different size, material, or design than those listed in the APL, the design engineer must seek approval by the PDRC prior to their use (excludes products requested as "approved equals" or substitutions to products currently on the APL; these requests shall go through the New Product Submittal and Review Process described below).

Use by Contractors:

The APL, by itself does not constitute a submittal by the contractor. The contractor must submit manufacturer technical data sheets of sufficient detail to adequately describe the product or materials for each project. Submittals shall address all requirements contained in the APL data sheet as well as applicable project specifications. The corresponding APL data sheet should accompany the submittal for listed projects.

Use by Contractor Submittal Reviewers:

The APL is intended to expedite reviews of product submittals made by contractors. Contractor submittal reviewers must confirm the following to ensure that products comply with the APL:

- The product meets the functional needs of the project.
- The product is of the type specified for use on the project.
- The product is in the category covered by the APL.
- The manufacturer of that product is listed on the APL.
- The product is within the size range listed on the APL.
- The model number, serial number or manufacturer designation is listed on the APL.
- The product meets all requirements in the applicable specifications, special provisions, details and construction notes in the project contract documents.

General Notes and Requirements:

1. Contractors shall confirm that the construction contract documents for City of Mesa Capital Improvement Projects (CIPs) allow for use of products on the APL. Project-specific Special Provisions or Technical Specifications in the project contract documents may specify other products, in which case the project specifications shall govern.

Created: 12/17/12
Revised: 12/29/22

GENERAL NOTES AND REQUIREMENTS

W-1



CITY OF MESA APPROVED PRODUCTS LIST – WATER

2. Projects under construction shall only utilize products on the current Approved Products List. No substitutions or "approved equal" products will be allowed. Product manufacturers or representatives wishing to submit products for consideration shall follow the procedures listed in this document and furnish the requested information.
3. Standards referenced in the Approved Product List shall be the latest version of that standard, regardless of the year or date indicated.
4. After an item is approved, the product manufacturer or representative shall inform the City in writing, of any subsequent modifications in product design or material. Changes in product design or material may require further evaluation to determine continued approval of the product. Failure to inform the City of such changes may result in removal of the item from the Approved Products List.
5. The City may withdraw any approval as a result of design or material change, field observation, testing, product failure, or other factors which, in the City's opinion, warrant such withdrawal.
6. Projects under construction that include public water system components by private developers, or other non-CIP projects shall adhere to the APL requirements and only use listed products where applicable unless otherwise approved in writing by the City.
7. Assembled products, and the materials associated with assembled products, may be subject to testing for conformance to applicable standards and manufacturer's specifications for that product.
8. The City may limit the number of approved products for certain items that require specialized tools, training, excessive storage or reduce the efficiency of maintenance and operations activities.

New Product Submittal and Review Checklist:

Product and equipment manufacturers wishing to have a product reviewed for inclusion on the APL shall submit a complete written request to the Water PDRC. This should be submitted as a single package for each product and include the following:

1. Identify the product and City of Mesa APL number to which the product would be added (if applicable).
2. Identify the Maricopa Association of Governments (MAG) Standard Specification and City of Mesa MAG supplemental standard specifications that govern the product, where applicable.
3. Describe the product, providing technical specifications, dimensional drawings, product weights and catalog information.*
4. If the product is proposed as an addition to a current Approved Product sheet, demonstrate compliance with listed requirements in the corresponding sheet.*
5. Indicate compliance with applicable AWWA, ASTM, ANSI, NFPA, UL, FM, ISO 9001 or other related standards or specifications that govern the product.*
6. Provide evidence of NSF registration for products to be used in a potable water system.*
7. Provide an example submittal for review by the committee. The example submittal shall contain the same level of detail as that provided by a contractor during construction.

<p>Created: 12/17/12 Revised: 12/29/22</p>	<p>GENERAL NOTES AND REQUIREMENTS</p>	<p>W-1</p>
--	--	-------------------



CITY OF MESA APPROVED PRODUCTS LIST – WATER

8. Indicate country of origin for all product components.**
9. Name, address and phone number of local product representative.
10. Product availability, delivery time, pricing, and manufacturer's location. If both foreign and domestic options are offered, provide availability, pricing, and delivery time for each.
11. Provide test results showing compliance with applicable standards, or other relevant testing information, including independent laboratory test results.
12. Provide manufacturer's installation procedures for the product.
13. List maintenance requirements, special equipment and procedures and recommended maintenance schedules.
14. List a minimum of three (3) project owners (public utilities) who have the product installed and currently in use, local or within Arizona preferred. Include project name and location, project owner's contact name, address, and telephone number, and product application (including sizes) and number of years in use.
15. Provide a material safety data sheet (MSDS), if applicable.
16. Describe recent product revisions or improvements.
17. Explain how the product would benefit the City of Mesa in terms of prolonged service life, reduced maintenance, and reduced life-cycle cost compared to products now in use.

*This information must be shown as part of the manufacturer's publicly-available product literature. Separate letters or statements indicating compliance with these requirements may be rejected.

**If portions of the product are cast, manufactured, or assembled outside of the U.S.A, provide specific information as required for each component. If the product is primarily non-domestic and a "Domestic" option is available, manufacturers shall indicate this. If the "Domestic" option is not 100% made-in-the U.S.A., the submittal package shall indicate which components are cast, manufactured, or assembled outside of the U.S.A, and the corresponding country for each.

New Product and Select Service Contractor Submittal Details:

Electronic submittals in PDF-format or other common formats (Word, etc) are acceptable. Electronic submittals (10 MB maximum) shall be made to the Product Design and Review Committee at:

DSayre@mesaaz.gov

Hard-copy submittals, in addition to, or in lieu of electronic copies are also acceptable. Three (3) hard-copy submittals shall be sent to:

**Water Product and Design Review Committee
 City of Mesa Water Resources Department
 640 North Mesa Drive
 PO Box 1466
 Mesa, AZ 85211**

<p>Created: 12/17/12 Revised: 12/29/22</p>	<p>GENERAL NOTES AND REQUIREMENTS</p>	<p>W-1</p>
---	--	-------------------



CITY OF MESA APPROVED PRODUCTS LIST – WATER

New Product and Select Service Contractor Review Process:

If the submittal is found to be acceptable, the PDRC chairperson will submit it to the entire committee, who may request additional information or products for testing or field evaluation. Following submittal reviews, the committee may ask the manufacturer to demonstrate the product or service.

The PDRC typically meets on a quarterly basis. A majority vote by the committee is required to accept any new product or service to add it to the Approved Products List. The committee will advise the applicant of the decision regarding the product following the next quarterly review meeting. The PDRC may rescind an approval of an approved product or service if failures in service occur, or maintenance issues arise.

Revisions to Published APL Sheets:

In general, revisions to existing APL product sheets will be published on a quarterly basis according to the schedule below. Only those sheets requiring modifications will be revised, with corresponding revision dates posted on impacted sheets. New APL sheets may be generated and published as required at the discretion of the PDRC.

City of Mesa Water APL Quarterly Revision Schedule:

1ST Quarter: Last week of March

2ND Quarter: Last week of June

3RD Quarter: Last week of September

4TH Quarter: 3RD Week of December

Created: 12/17/12
Revised: 12/29/22

GENERAL NOTES AND REQUIREMENTS

W-1

CITY OF MESA APPROVED PRODUCTS LIST - WATER

DESIGN/MATERIALS:

- Fire Hydrants shall be of the dry-barrel type.
- Hydrants shall comply with the latest edition of AWWA C502, MAG Sec. 756 and the City of Mesa Amendment to the MAG Uniform Standard Specifications and Details unless indicated otherwise herein.
- Hose Nozzles:
 - Two (2) 2-½-inches in diameter with National Standard Threads
 - One (1) steamer connection, 4 ½-inches in diameter with National Standard Threads.
- Main Valve Seat Opening Dia: 5-1/4 in. min.
- Min. Pressure Rating: 250 psig working; 500 psig hydrostatic (factory tested).
- Hydrants shall be of the break-flange traffic model type with a replaceable breakable unit immediately above the ground line.
- Hydrant nozzle section shall be capable of rotation through 360 degrees to at least 8 points of rotation with respect to the standpipe.
- Interior Coating: All interior ferrous surfaces of the shoe exposed to water shall be coated with a 100% powder epoxy or liquid epoxy (6 mil. Min. DFT) that conforms to AWWA C 550-81 and NSF-61.
- Exterior Coating: Coating shall be one of the following:
 - 1) Triglycidyl Isocyanurate (TGIC) polyester coating meeting the following:

Hardness:	ASTM D 3363
Impact Resistance:	ASTM D 2794
Chip Resistance:	ASTM D 3170
 - 2) Prime coated with an epoxy and finish coated with a two-part polyurethane top coat meeting the following:

Corrosion Resistance:	ASTM B 117-02
-----------------------	---------------
- Damaged Coating Repair: Chipped or damaged coatings shall be repaired using, at a minimum, a two part system comprised of an epoxy primer base coat and polyurethane topcoat meeting the requirements of MAG Specification Section 756. The coating shall be fade and UV resistant, and the color shall match the factory color. Surface preparation shall be per manufacturer recommendations. If paint touch up kits are available from the hydrant manufacturer, those shall be utilized for coating repairs.



**Waterous Pacer
WB-67-250**



Clow Medallion



**Mueller Super
Centurion**

Approved Models:

1. WATEROUS PACER MODEL WB-67-250
2. CLOW MEDALLION
3. MUELLER SUPER CENTURION A423

Created: 12/17/12
Revised: 04/01/19

FIRE HYDRANTS

W-2



CITY OF MESA APPROVED PRODUCTS LIST - WATER





- Coating shall be a semi-gloss, bright chrome safety yellow in color with high color retention.
- Coating shall be fade and UV resistant, rust resistant, resistant to abrasions and chipping and have flexibility qualities.
- Hydrants shall have markings indicating direction of opening right to left (counter-clockwise).
- Hydrants shall have permanent markings identifying the manufacturer name, model identification, size of the main valve opening and the year of manufacture.
- Hydrants shall be designed to allow all working parts to be removed through the bonnet/dome or upper nozzle section of the hydrant without removal of the entire upper barrel section.
- All Fire hydrants must have bronze-to-bronze seat retainer to ensure easy removal of main valve.
- All nuts and bolts of the factory hydrant to be buried below ground will be a minimum of 304 stainless steel and coated for thread gall protection.
- Maximum Permissible Head Loss:
 - Maximum permissible loss of head for 2-1/2" and 4" outlet nozzles shall be per AWWA C502, latest edition.
- Warranty: Provide a 5-year (minimum) manufacturer's warranty, beginning at date of acceptance by the City of Mesa.

NOTES:

1. For new work, the minimum depth of bury shall be 3 feet 6 inches, and the maximum shall be 5 feet from the breakaway flange to the shoe.
2. For fire hydrant installations requiring depth of bury greater than 5 feet from the breakaway flange to the shoe, the fire hydrant may be equipped with a vertical shoe arrangement, or a Gradelok connector pipe, manufactured by Assured Flow Sales, may be used. The maximum depth of bury for vertical shoe installations shall not exceed 5 feet.
3. The contractor shall be responsible for adjusting the hydrant to meet the specifications outlined in MAG Standard Detail 360. Installed hydrants shall not utilize more than one (1) extension with a maximum length of 18-inches.
4. Standard lubricants shall be food-grade oils or greases suitable for temperatures between 20 degrees and 150 degrees F.
5. Should the ground line adjacent to an existing fire hydrant change due to landscaping and/or construction, the Contractor shall be responsible for adjusting the hydrant to meet the specifications outlined in MAG Standard Detail 360.
6. The minimum allowable distance between the centerline of the lowest nozzle and the ground line is 18 inches, and the maximum allowable shall be 24 inches. The bury line shall be visibly marked on the lower barrel of hydrant.

Created: 12/17/12 Revised: 04/01/19	FIRE HYDRANTS	W-2
--	----------------------	------------

CITY OF MESA APPROVED PRODUCTS LIST - WATER

<p>DESIGN REQUIREMENTS:</p> <ul style="list-style-type: none"> • Mechanical joint restraints shall utilize conventional tools and installation procedures per AWWA C600, while retaining full mechanical joint deflection during assembly as well as allowing joint deflection after assembly. • Proper actuation of the gripping wedges shall be ensured with torque limiting twist off nuts. • Restraint glands shall restrain pipe conforming to the requirements of ANSI/AWWA/C151/A21.51. • Restraints shall be Underwriter Laboratories (UL) listed for ductile iron pipe for sizes 3" through 12". <p>MATERIALS:</p> <ul style="list-style-type: none"> • GLANDS: Ductile (nodular) iron, meeting or exceeding ASTM A536, Grade 65-45-12. • WEDGES: Ductile iron heat treated to a minimum hardness of 370 BHN. • GASKETS: Standard MJ gaskets per ANSI/AWWA C111/A21.11. • RESTRAINING LUGS: Ductile (nodular) iron, meeting or exceeding ASTM A536. • BOLTS: Tee head bolts conforming to the requirements of ANSI/AWWA C111/A21.11 and ANSI/AWWA C153/A21.53. • COATING: Restraint bodies, wedge assemblies and related components shall be coated with fusion-bonded epoxy, electrostatically-applied heat-cured epoxy, or electrostatically-applied heat-cured polyester coating. • DOMESTIC IRON REQUIREMENT: Ductile iron castings shall be manufactured, assembled, inspected, and packaged in the U.S.A. Contractor's submittals shall include supporting documentation. <p>NOTES:</p> <ol style="list-style-type: none"> 1. Restraints are not to be used on plain-end fittings or gray-iron pipe. 2. Restraints for use on ductile-iron pipe shall be colored black. 3. Approved models are only for use on ductile-iron pipe. 4. Unless otherwise specified in the project documents, restraints shall be furnished in a boxed package, including restraint glands, bolts, nuts and gasket. 5. Domestic or non-domestic tee head bolts, nuts, and gaskets are acceptable. 6. All referenced standards reflect the latest revision. 7. Working pressure: 3" to 16" - 350psi, 18" and up - 250psi. 	 <p>EBAA MegaLug Series 1100</p>  <p>Ford Uni-Flange Series 1400</p>  <p>Romac RomaGrip</p>  <p>Star Pipe Products Stargrip Series 3000</p>  <p>Tyler Union Tuf Grip Series 1000</p>
<p>Created: 12/17/12 Revised: 07/01/20</p>	<p>Approved Models:</p> <ol style="list-style-type: none"> 1. <u>EBAA MEGALUG SERIES 1100</u> (Domestic Only) SIZES: 3"-48" #1103 through #1148. 2. <u>FORD UNI-FLANGE SERIES 1400</u> (Domestic Only) SIZES: 3"-48" #UFR1400-D-3-U through #UFR1400-D-48-U 3. <u>ROMAC ROMAGRIP</u> (Domestic Only) SIZES: 3"-24" #3" RGAP-D through #24" RGAP-D 4. <u>STAR PIPE PRODUCTS STARGRIP</u> (Domestic Only) SIZES: 3"-36" #SGDPS03DD - #SGDPS36DD (Part No. provided by Star Pipe) 5. <u>TYLER UNION TUF GRIP 1000</u> (Domestic Only) SIZES: 3"-48" #6009XX Domestic
<p>MECHANICAL JOINT RESTRAINTS FOR DUCTILE IRON PIPE</p>	
<p>W-3</p>	

CITY OF MESA APPROVED PRODUCTS LIST - WATER

DESIGN REQUIREMENTS:

- This specification encompasses gate valves of resilient wedge design for water service, sizes 4” through 36” per latest revisions of AWWA C509 & AWWA C515.
- All gate valves encompassed by this specification shall have a minimum working pressure of 250 psi. Valve sizes 2” through 20” shall be in accordance with AWWA C509 or C515. Valves 24” and larger shall be in accordance with AWWA C515.
- Gate valves above 36” in size and valves utilized at critical facilities such as water treatment or pumping facilities may need to meet additional requirements as stated in project specifications and drawings.
- Gate valves shall conform to the requirements of MAG Specification 630, and City of Mesa amendments thereof.
- Gate valves shall be of the non-rising stem type and shall be counter-clockwise opening.
- Gate valves shall have a 2” square operating nut for buried service. Other operator types, including hand wheels, may be provided for above ground service as indicated by specific project specifications & drawings.
- Ductile/Cast iron wedges shall be fully encapsulated with molded rubber compliant with ASTM D2000.
- All interior ferrous surfaces shall be factory epoxy coated to a minimum dry film thickness of 6 mils.
- All exterior ferrous surfaces, except finished or bearing surfaces, shall be factory epoxy coated to a minimum dry film thickness of 6 mils.
- Flanges, if required, shall be per AWWA C110 or ANSI B16.1, class 125. Mechanical joint connections shall meet AWWA C111, latest revision.
- Gate valves shall not be installed in the horizontal position without prior written approval by the City of Mesa Water Resources Department.
- Gate valves shall be certified to, or compliant with, ANSI/NSF Standard 61.
- Rubber O-ring seals shall be utilized for the stuffing box and bonnet.
- Valve boxes shall be installed per MAG Standard Detail 391-1, Type C, with a 4” deep skirted lid.
- Debris Caps – Valve Sizes Above 16”: Install debris cap in valve boxes per MAG Standard Detail 392.
- Debris Caps – Valve Sizes 16” and Smaller: Do not install debris caps unless otherwise indicated by project plans and specifications.



American Flow Control Series 2500



Clow Valve Co. Models 2638, 2639, and 2640



Kennedy Valve KS-FW & KS-RW



Mueller Services 2361 & 2362



U.S. Pipe Valve & Hydrant Series A-USP1

Approved Valve Models:

1. AMERICAN FLOW CONTROL SERIES 2500
2. CLOW VALVE CO. 2638, 2639, 2640
3. KENNEDY VALVE SERIES KS-FW & KS-RW
4. MUELLER SERVICES 2361 & 2362
5. U.S. PIPE VALVE & HYDRANT SERIES A-USP1

Approved Valve Box Heavy Lid Models: *

1. TYLER UNION 145451 5-1/4” 25LB DROP LID

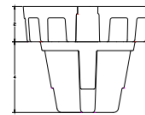

* Approved on a case by case basis or where plans or specifications indicate heavy lid use.

Created: 12/17/12
Revised: 09/15/22

GATE VALVES & APPURTENANCES

W-4



CITY OF MESA APPROVED PRODUCTS LIST - WATER

MATERIAL REQUIREMENTS:

- GRAY IRON: Gray iron shall meet or exceed the requirements of ASTM A126 Class B.
- DUCTILE IRON: Ductile iron shall conform to the requirements of ASTM A536.
- COPPER ALLOYS: Copper alloys shall conform to the requirements of MAG specification 630 and AWWA C509 & C515. Copper alloys in contact with drinking water shall comply with the Safe Drinking Water Act.
- GASKETS: O-rings/gaskets shall be suitable for use in potable water systems and shall meet the requirements of ASTM D2000.
- COATINGS: Interior and exterior factory applied coating for ferrous surfaces shall be fusion bonded applied, shall conform to the requirements of AWWA C550, and shall be ANSI/NSF 61 certified or compliant.
- BOLTS AND NUTS: Bolts and nuts shall conform to the requirements of AWWA C509 or AWWA C515.

Created: 12/17/12
Revised: 09/15/22

GATE VALVES & APPURTENANCES

W-4

CITY OF MESA APPROVED PRODUCTS LIST - WATER

DESIGN REQUIREMENTS:

- Combination air/vacuum valves shall comply with MAG Specification Section 630.6.
- Combination air/vacuum valves shall comply with AWWA C512, latest edition.
- This Approved Products List section encompasses 2" combination air valves only, installed on waterlines 16" diameter and under.
- This Approved Products List section applies to water distribution pipelines only and is not intended to be utilized for valve selection for pipelines designated by the City of Mesa Water Resources Department as transmission mains, supply mains, or well collection lines.
- Design calculations shall be prepared and submitted for review and acceptance by the City of Mesa for proposed air valves on waterlines greater than 16-inches in diameter.
- Combination air valves shall be designed for use in water systems with a maximum working pressure of 285 psig.
- Materials utilized in air/vacuum valves shall be compliant with the Safe Drinking Water Act.
- Combination air valves encompassed by this section shall be ANSI/NSF certified or compliant.
- The valve body and cover shall be constructed of gray cast iron or ductile iron.
- Valve trim materials shall be inherently corrosion resistant.
- Valves shall be factory tested per the requirements of AWWA C512, latest edition, to 150% of the maximum working pressure.
- External valve coating shall be factory applied fusion bonded or electrostatically applied heat cured epoxy.

MATERIAL REQUIREMENTS:

- GRAY IRON: Shall meet or exceed the requirements of ASTM A126 Class B or ASTM A48 Class 35.
- DUCTILE IRON: Ductile iron shall conform to the requirements of ASTM A536 grade 65-45-12.
- BRONZE: Parts subject to wetting shall be constructed of low zinc alloys per AWWA C512.
- O-RINGS: Shall be in accordance with ASTM D2000.
- COVER BOLTING: Shall meet or exceed the minimum physical strength properties of ASTM A307.
- VALVE TRIM: Valve trim materials shall be type 304 or type 316 stainless steel.
- FLOAT: The float material shall be type 304 or type 316 stainless steel.
- COATING: Factory applied fusion bonded or electrostatically applied heat cured epoxy.

INSTALLATION NOTES:

- Combination air/vacuum valves installed below ground shall be constructed per City of Mesa Standard Detail M-38.01 and M-38-03.
- All combination air/vacuum valves shall be installed with a vent pipe and insect screen per City of Mesa Standard Detail M-38.01. The vent pipe diameter shall match the vacuum valve outlet diameter. See this sheet for approved insect screen (Approved Gooseneck Vent Cap Model).
- Combination air/vacuum valves installed with hoods are prohibited.



Val-Matic 202C.2 - 2"



Cla-Val 36 CAV - 2"

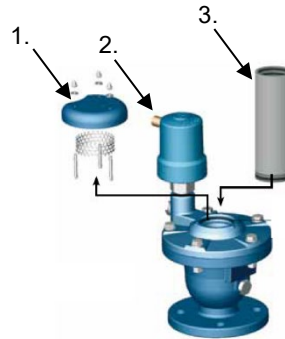

A.R.I. D060-C HF & D062 HF - 2"
(See Notes Below)



deZurik/APCO 145C - 2"

1. Hood to be removed
2. Air release outlet brass tube connection point.
3. Galvanized vent piping to above ground gooseneck.

Approved Models:

1. VAL-MATIC SERIES 202C.2 - 2"
2. CLA-VAL 36 CAV - 2"
3. A.R.I. MODEL D-060-C HF & D062 HF - 2"
4. DEZURIK/APCO SERIES 145C - 2"

Approved Gooseneck Vent Cap Model:

1. CHRISTY'S VCM2 - 2"
2. NORTHTOWN HYTECH BUGSCRN-2"M



Created: 12/17/12
Revised: 07/01/20

COMBINATION AIR VALVES

W-5

CITY OF MESA APPROVED PRODUCTS LIST - WATER

DESIGN REQUIREMENTS:

- This specification encompasses tapping sleeves for potable water service. The intent of this specification is to cover tapping sleeves for existing water mains only.
- Tapping sleeves shall not be utilized in situations where the outlet diameter is equal to, or larger than, the pipe being tapped.
- Tapping sleeves may be installed on asbestos cement pipe (ACP), ductile iron pipe (DIP), cast-iron pipe (CIP), and concrete cylinder pipe (CCP, AWWA C303).
- Tapping sleeves may be prohibited for use on asbestos cement pipe (ACP) which is found to be in degraded condition or installed prior to 1980.
- Tapping sleeves installed on CCP shall meet the requirements of this specification, and the City of Mesa Amendments to MAG Uniform Standard Specifications for Public Works Construction, current edition.
- Prior written approval is required from the City of Mesa Water Resources Department for the installation of tapping sleeves on pipe larger than 16".
- Tapping sleeves encompassed by this specification shall be epoxy coated fabricated steel or all-stainless steel, with fully passivated welds, and shall conform to applicable sections of AWWA C200, C220 & C223, latest editions, and MAG specification section 630.4. Refer to project plans and specifications to determine whether an all-stainless version may be required.
- Epoxy coated tapping sleeves shall be fully epoxy coated including sleeve and outlet, except for stainless steel components.
- Tapping sleeves shall be designed to for the pressure requirements of the pipeline, including surge pressures and safety factors, and shall be installed and tested per MAG specification section 630.4 and the City of Mesa Amendments to MAG Uniform Standard Specifications for Public Works Construction.
- Outlet flanges shall conform to AWWA C223 and AWWA C207, latest editions, as applicable.
- Sleeve outlet flange isolation may be required. Refer to project specific plans and specifications prior to installation.

MATERIAL REQUIREMENTS – STAINLESS STEEL TAPPING SLEEVES FOR DIP, ACP, AND CIP:

- **SHELL & BRANCH OUTLET:** Type 304 stainless steel per ASTM A240 & AWWA C220.
- **FLANGE:** Type 304 stainless steel per ASTM D240.
- **BOLTS:** Type 304 stainless steel per ASTM F593, ASTM F738M, or ASTM A193.
- **NUTS:** Type 304 stainless steel per ASTM F594, ASTM F863M, or ASTM A194 (Coated with anti-seize).

MATERIAL REQUIREMENTS – STAINLESS STEEL TAPPING SLEEVES FOR DIP, ACP, AND CIP (CONT):

- **LUGS:** 304 stainless steel per ASTM A240.
- **SHELL & BRANCH GASKET:** Shell gasket shall be full circumferential. Gaskets shall be suitable for potable water service for water service temperatures to 150° F, and shall be certified to, or compliant with NSF-61. Suitable materials: SBR, NBR, or EPDM.
- **WASHERS:** Washers shall be type 304 stainless steel.

MATERIAL REQUIREMENTS – EPOXY COATED STEEL TAPPING SLEEVES FOR DIP, ACP, AND CIP PIPE:

- **SHELL & BRANCH OUTLET:** Carbon steel per ASTM A36, ASTM A283 & AWWA C200.
- **FLANGE:** Steel per AWWA C207.
- **BOLTS & NUTS:** Type 304 or type 316 stainless steel per AWWA C223.
- **WASHERS:** If provided, washers shall be type 304 stainless steel.
- **BRANCH GASKET:** Gaskets shall be suitable for potable water service and shall be certified to, or compliant with NSF-61. Suitable materials are SBR, NBR, or EPDM per ASTM D2000.
- **LUGS:** Carbon steel per ASTM 283 or ASTM A36.
- **COATING:** Factory applied fusion bonded, electrostatically applied, or liquid epoxy per AWWA C210 or C213. The entire assembly shall be epoxy coated, including the sleeve and outlet.

Stainless Steel Models – For DIP, ACP, and CIP:

1. CASCADE MODEL CST-EX
2. FORD MODEL FTSS
3. JCM MODEL 432
4. POWER SEAL MODEL 3490
5. ROMAC SST
6. SMITH-BLAIR MODEL 663
7. TPS TRIPLE TAP SERIES TS



Epoxy Coated Steel Models – For DIP, ACP and CIP:

1. CASCADE MODEL CFT-ESS
2. FORD MODEL FTSC
3. JCM MODEL 412
4. POWER SEAL MODEL 3460CS
5. ROMAC FTS420
6. SMITH-BLAIR MODEL 622

Approved Models - Tapping Sleeves for CCP Pipe:

1. JCM MODEL 415
2. SMITH-BLAIR MODEL 625

Revised: 12-29-22

Page: 1 OF 2

TAPPING SLEEVES

W-6



CITY OF MESA APPROVED PRODUCTS LIST - WATER

<u>MATERIAL & DESIGN REQUIREMENTS –TAPPING SLEEVES FOR C303 CONCRETE CYLINDER PIPE (CCP):</u>	<u>NOTES FOR INSTALLATION & TESTING OF TAPPING SLEEVES ON C303 CONCRETE CYLINDER PIPE (CCP):</u>
<p>Tapping sleeves encompassed by this specification shall be epoxy coated fabricated steel or stainless steel conforming to AWWA C223 and MAG Standard Detail 342.</p> <p>Fabricated tapping sleeve bodies and lugs shall be carbon steel that meets or exceeds the requirements of AWWA C200, or type 304 stainless steel per ASTM A240 and AWWA C220.</p> <p>Coating for carbon steel tapping sleeves shall be factory applied fusion bonded, electrostatically applied, or liquid epoxy per AWWA C210 or AWWA C213. The entire sleeve shall be epoxy coated. No coating is required for stainless steel tapping sleeves.</p> <p>Tapping flanges for carbon steel tapping sleeves shall meet the requirements of AWWA C207. Flange class shall be AWWA C207 Class D ANSI 150 lb. drilling, unless otherwise specified by project specific specifications, and be recessed for tapping valve per MSS-SP 60.</p> <p>Tapping flanges for stainless steel tapping sleeves shall meet the requirements of AWWA C207, except the material shall be type 304 stainless steel per ASTM A240. Flange class shall be AWWA C207 Class D ANSI 150 lb. drilling, unless otherwise specified by project specific specifications, and be recessed for tapping valve per Manufacturers Standardization Society SP 60. See MAG Specification Section 630 for more information.</p> <p>Tapping sleeves shall be provided with grout ports.</p> <p>Branch gaskets shall be compounded for potable water service and shall be certified to, or compliant with NSF-61 and NSF-372. Acceptable branch gasket materials are SBR, NBR, or EPDM per ASTM D2000.</p> <p>Unless otherwise indicated by project specific provisions, flange isolation kits shall be installed between the tapping sleeve and tapping sleeve valve. See APL sheet W-21 Corrosion Protection Systems for approved isolation kits.</p> <p>Bolting shall be stainless steel per AWWA C223. Bolts shall be type 304 stainless steel per ASTM A593 or ASTM A193. Nuts shall be type 304 stainless steel per ASTM A594 or ASTM A194.</p> <p>A 3/4" test connection shall be provided per AWWA C223.</p> <p>Tapping sleeves shall be certified to NSF/ANSI 61 Annex G, and NSF/ANSI 372.</p> <p>Tapping sleeves shall be designed to meet the requirements of AWWA M-9 – Concrete Pressure Pipe, current edition.</p>	<p>1. General Requirements:</p> <p>A. Installation shall be performed by an approved contractor per City of Mesa Approved Products List – Water, W-7 Approved Wet Tap Contractors.</p> <p>B. Tapping sleeves shall not be placed within 36" of any fitting, coupling, valve, or joint.</p> <p>C. Tapping sleeve installation and testing on concrete pressure pipe shall be witnessed by a City of Mesa Engineering Construction Inspector (Inspector).</p> <p>D. Connections to existing CCP shall be approved in writing by the Water Resources Department prior to construction.</p> <p>2. Design & Installation Requirements:</p> <p>A. Thrust restraint and thrust block sizing shall be per AWWA M9 Concrete Pressure Pipe Manual of Practice. If not detailed in the project specific plans and specifications, sealed engineering calculations and details supporting the design shall be submitted to the City for review and approval. Thrust block material and installation shall be in conformance with MAG Specifications.</p> <p>B. Valve blocking/support sizing shall be per project specific plans and specifications.</p> <p>C. Installation of tapping sleeves encompassed by this specification shall conform to AWWA M9, manufacturers installation instructions, and MAG Standard Detail 340.</p> <p>D. The gland gasket position shall be checked with a feeler gauge per manufacturer's recommendations.</p> <p>E. The gland gasket seal and gland cavity shall be tested for water tightness per AWWA M9 and manufacturer's recommendations. The fluid test pressure shall not exceed the pressure inside the pipe being tapped, and the duration of the test shall be per manufacturer's recommendation.</p> <p>F. Following pressure testing and acceptance by the Inspector, tapping of the pipe may be completed. The coupon removed during tapping shall be provided to the Inspector or representative of the City of Mesa Water Resources Department.</p> <p>G. After tapping is complete the tapping valve shall be opened slightly to flush out any cuttings that remain.</p> <p>H. Fill the space between the saddle and the gland with grout and backfill with half-sack CLSM per MAG Specification Section 728 to a minimum of 6" above the pipe.</p>



CITY OF MESA APPROVED PRODUCTS LIST - WATER

<p><u>SCOPE:</u></p> <ul style="list-style-type: none"> This specification and list applies to water line taps for lateral lines 4" and larger. <p><u>DESIGN & MATERIAL REQUIREMENTS:</u></p> <ul style="list-style-type: none"> Listed hereon are the approved contractors for making wet taps on the City of Mesa water system. Wet tap installation shall conform to MAG Specification Section 630 and City of Mesa requirements. Tapping sleeves shall be per City of Mesa Approved Products List W-6 Tapping Sleeves. Line stop sleeves shall be all stainless steel and shall meet applicable standards as indicated per City of Mesa Approved Products List W-6 Stainless Steel Tapping Sleeves. Gate valves utilized in the process of tapping sleeve installation shall be per City of Mesa Approved Products List W-4, Gate Valves. Product shop drawing submittals for tapping sleeves and associated gate valves must be approved by the City of Mesa prior to installation. Approved wet tap contractors shall have a current Arizona contractor's license of the appropriate class to perform wet tap connections on water mains. <p><u>CONTRACTOR SUBMITTAL REQUIREMENTS:</u></p> <ul style="list-style-type: none"> See Water APL sheet W-1 for general submittal requirements in addition to those listed below. Only primary contractors will be considered for inclusion on this APL. The primary contractor shall perform the services, and meet the qualifications listed hereon. Provide a minimum of three professional references for recent work performed within the state of Arizona for performing hot taps on potable water systems. Provide relevant Arizona contractor's license numbers. Describe your firms experience with one or more of the approved tapping sleeves per APL W-6. 	
<p>Created: 12/17/12 Revised: 12/21/22</p>	<p>Approved Contractors:</p> <ol style="list-style-type: none"> KOPPL PIPELINE SERVICES PHONE: 323-888-2211 INTERNATIONAL FLOW TECHNOLOGIES PHONE: 1-800-221-3332 PIPELINE SERVICES, INC. PHONE: 480-675-8767 ARIZONA TAP MASTER, INC. PHONE: 623-776-3132
<p>APPROVED WET TAP CONTRACTORS</p>	
<p>W-7</p>	



CITY OF MESA APPROVED PRODUCTS LIST - WATER





<p><u>DESIGN REQUIREMENTS:</u></p> <ul style="list-style-type: none"> • All component types listed within requiring low lead brass under the Safe Water Drinking Act shall be etched or integrally cast with a manufacturer designation indicating compliance with the regulatory requirement. • Service line valves and fittings shall conform to the requirements set forth in the latest version AWWA C800. • Service line valves and fittings shall be NSF 61 compliant or certified. • Service line valves and fittings, other than service saddles, shall meet the requirements of NSF 61 and NSF 372 for brass alloy lead content. • Brass service saddles shall be rated for 200 psig maximum working pressure. • Service line valves and fittings, other than service saddles, shall be rated for 300 psi working pressure. • Brass service saddles shall have IP type thread. • Corporation stops shall be ball style with male IP inlet by CTS pack joint outlet and shall have a fluorocarbon coated brass ball. • Curb stops shall be ball style with locking wings. • Outlet meter couplings for 3/4" to 1" service lines shall be of straight coupling design with meter swivel nut by male IP. • Outlet meter couplings for 1-1/2" to 2" shall be flanged by female IP. Bolts & nuts shall be 316 grade stainless steel. • Insulating corporation stops shall effectively electrically isolate water mains from copper service lines. Piping adjacent to insulating valves shall be wrapped to a minimum of three feet beyond the valve to prevent stray current from traveling around the insulator. Pipe tape shall be 8 mil polyethylene and wrapping shall be per AWWA C209. <p><u>MATERIALS:</u></p> <ul style="list-style-type: none"> • <u>SERVICE SADDLES:</u> <ul style="list-style-type: none"> • Body: All brass conforming to ASTM B62 and ASTM B584, UNS C83600. • Strap: Silicon bronze conforming to ASTM B584. • Gaskets: EPDM or NBR per ASTM D2000. Gaskets shall comply with NSF 61 requirements for water service temperatures of up to 100° F. • Nuts: ASTM B62 C83600 or ASTM B98 C65100. • <u>CORPORATION STOPS:</u> <ul style="list-style-type: none"> • Castings: All brass in contact with potable water shall conform to AWWA C800, ASTM B584, UNS C89833. • Seals: EPDM, NBR, or SBR per ASTM D2000. Seals shall comply with NSF 61 standards. • Insulator Bushing: Nylon, or other approved NSF-61 compliant dielectric material. <p align="center">*Single strap service saddles are not permitted on water mains larger than 8 inches in diameter.</p>	<p>Approved Models:</p> <ol style="list-style-type: none"> 1. Service Saddles 3/4" & 1" *: Jones J-975, J-979 (DIP, CIP) J-969 (ACP) Mueller BR1B, BR2B (DIP, CIP) BR2S (ACP) AY McDonald 3816 & 3826 Romac 101B & 202B Ford 101B & 202B 2. Service Saddles 1-1/2" & 2": Jones J-979 (DIP, CIP) J-969 (ACP) Mueller BR2B (DIP, CIP) BR2S (ACP) AY McDonald 3826 Romac 202B Ford 202B 3. Ball Style Corporation Stop 3/4" - 2": AY McDonald 74704B-22 Ford FB1100-NL Jones E1935 Mueller P-25028N 4. Insulating Corporation Stop 3/4" - 2": AY McDonald 74704BDB-22 Ford SI-FB1100-NL Mueller P-35028N (3/4" & 1" Only) 5. Ball Style Curb Stop 3/4" & 1": AY McDonald 74602B-22 Ford BA43W-NL Jones E1963W Mueller P-24258N 6. Ball Style Curb Stop 1-1/2" & 2": AY McDonald 74602B-22 Ford BFA43W-NL Jones E1975W Mueller P-24276N 7. Outlet Meter Coupling 3/4": Ford C38-23-2-5-NL AY McDonald 74620 3/4 x 2.75 Mueller H10890N James Jones E130 8. Outlet Meter Coupling 1": Ford C38-44-2-625-NL AY McDonald 74620 1 x 2.63 Mueller H10890N James Jones E130 9. Outlet Meter Coupling 1-1/2": Ford CF-31-66-NL AY McDonald 7610F 1.5" Mueller H10129N James Jones E129 	
<p>Created: 03/13/13 Revised: 10/05/23</p>	<p align="center">UNDERGROUND SERVICE LINE VALVES & FITTINGS</p>	<p align="center">W-8</p>



CITY OF MESA APPROVED PRODUCTS LIST - WATER

<p><u>MATERIALS (Cont.):</u></p> <ul style="list-style-type: none"> • <u>CURB STOPS:</u> <ul style="list-style-type: none"> • Castings: All brass in contact with potable water shall conform to AWWA C800, ASTM B584, UNS C89833. • Seals: EPDM, NBR, or SBR per ASTM D2000. Seals shall comply with NSF 61 standards. • <u>CURB STOP CAPS FOR SERVICE ABANDONMENT:</u> <ul style="list-style-type: none"> • Castings: No lead brass for potable water use conforming to AWWA C800, latest edition. • Gaskets: EPDM, NBR, or SBR per ASTM D2000. Gaskets shall comply with NSF 61 standards. • Pressure Rating shall be equal to the valve to which it is installed. • <u>METER COUPLINGS:</u> <ul style="list-style-type: none"> • Castings/Body: All brass in contact with potable water shall conform to AWWA C800, ASTM B584, UNS C89833. • Gaskets/Seals: Shall comply with NSF 61 requirements and be approved for use in potable water systems. • <u>METER BOXES AND COVERS:</u> <ul style="list-style-type: none"> • Meter box assemblies for meter sizes 3/4" through 1" shall be constructed of polymer concrete bodies with polymer concrete frames. A mouse hole opening shall be provided at each end. • Meter box assemblies for meter sizes 1-1/2" to 2" shall be constructed of rotocast polyethylene bodies with polymer concrete frames. • Meter box covers shall be constructed of polymer concrete, have a non-skid surface, and include a pick hole. • Meter box covers shall be of non-bolt down type unless project specific plans and specifications indicate otherwise. • Ground level meter enclosures shall adhere to the requirements of ANSI/SCTE 77, latest edition. • When required, provide covers suitable for use with project specified Automated Meter Read (AMR) systems. • Unless otherwise indicated by project specific conditions, and approved in writing by Water Resources, meter boxes shall not be placed in locations subject to deliberate traffic. When approved, meter boxes and lids placed in areas subject to vehicles such as parking areas, driveways, or roadway shoulders shall be rated for H20 loading. 	<p>Approved Models (cont.):</p> <p>10. Outlet Meter Coupling 2": Ford CF-31-77-NL AY McDonald 7610F 2" Mueller H10129N James Jones E129</p> <p>11. Water Meter Boxes Assemblies for 3/4" through 1" Meters: Armorcast - ANSI/SCTE 77, Tier 15 Assembly: A6001429TA-H7S-PLUG Box: A6001429 Cover: A6001428T-H7S Plug: A60000H7-PLUG-CPA</p> <p>12. Water Meter Boxes and Covers, 1-1/2" through 2" Meters: Armorcast - ANSI/SCTE 77, Tier 15 Assembly: P6001534TAX12-H7S-PLUG Box: P6001534X12 Cover: A6001947T-H7S Plug: A60000H7-PLUG-CPA</p> <p>13. Water Meter Service Abandonment Curb Stop Caps – 3/4" – 2" Ford Meter Box Co Brass End Cap</p>	
<p>Created: 03/13/13 Revised: 10/05/23</p>	<p>UNDERGROUND SERVICE LINE VALVES AND FITTINGS</p>	<p>W-8</p>

CITY OF MESA APPROVED PRODUCTS LIST - WATER

<p><u>METER ADAPTERS:</u></p> <ul style="list-style-type: none"> When a meter is requested to be set for a differing service size, the customer is responsible to provide the meter adapters prior to, or at the time of meter installation. Per the City of Mesa Engineering & Design Standards section 317, that portion of the water service from the meter into the site is private and will be maintained by the property owner. As such, the property owner shall be responsible for any customer side size adapters or service piping adjustments necessary to fit a smaller meter. Per the City of Mesa Engineering & Design Standards section 317, service sizes shall be equal to, or one size larger than the requested meter size. Allowable service to meter size combinations: <ul style="list-style-type: none"> Service: 1" Meter: 3/4" Service: 1-1/2" Meter: 1" Service: 2" Meter: 1-1/2" The intent of this section is to provide guidance in the selection of the meter adapters necessary for the supply side of the meter and is not intended to cover all potential scenarios related to the customer side of the meter where service line sizing or lengths may differ from the City of Mesa Standard Details. <u>MATERIALS:</u> <ul style="list-style-type: none"> Castings: ASTM B584 UNS C89833 no lead brass conforming to AWWA C800. Adapters shall meet the requirements of NSF 61 and NSF 372 for brass alloy lead content. Adapters shall be integrally cast with NL or other designation indicating no-lead compliance. Adapter meter threads shall conform to AWWA C700. 	<p>Approved Models:</p> <ol style="list-style-type: none"> For 1" Service To 3/4" Meter: Ford A24-NL Jones E128HM AY McDonald 710J24 For 1-1/2" Service to 1" Meter: Ford A46-NL AY McDonald 710J46 For 2" Service to 1-1/2" Meter: Ford A67-NL AY McDonald 710J67   <p>Example: 1" Service To 3/4" Meter</p>   <p>Example: 1-1/2" Service To 1" Meter</p>  <p>Adapter: 2" Service To 1-1/2" Meter</p>	
<p>Created: 03/13/13 Revised: 10/05/23</p>	<p>UNDERGROUND SERVICE LINE VALVES AND FITTINGS</p>	<p>W-8</p>

CITY OF MESA APPROVED PRODUCTS LIST - WATER

DESIGN REQUIREMENTS:

- This specification encompasses ductile iron compact mechanical joint fittings for water service, sizes 4" through 36" per AWWA C153.
- Fittings encompassed by this specification shall meet the following minimum working pressure requirements: 4" through 24" - 350 psi, 30" through 36" - 250 psi.
- Fittings shall be UL listed in accordance with NSF/ANSI 61 and be compliant for use in potable water systems.
- Fittings shall conform to AWWA C153 for body thickness and dimensions.
- Dimensions for mechanical joint fitting bells and plain ends, gaskets, and accessories shall conform to AWWA C111.
- Fittings shall be integrally cast with required markings per AWWA C110 and C153.
- Fittings shall be exterior finished with asphaltic coating.
- Fittings shall be cement mortar lined, double thickness for fittings 6" and larger, single thickness for 4", with seal coat.

MATERIAL REQUIREMENTS:

- **DOMESTIC REQUIREMENT:** Ductile iron castings shall be manufactured, assembled, inspected, and packaged in the U.S.A. Contractor's submittals shall include supporting documentation.
- **DUCTILE IRON:** Ductile iron fittings shall be cast using ASTM A536 grade 70-50-05 or 65-45-12 ductile iron.
- **GLANDS:** Ductile iron meeting ASTM A536.
- **GASKETS:** Gaskets shall be suitable for use in potable water systems. Styrene-butadiene rubber (SBR) gaskets shall be standard. Nitrile Buna-N gaskets (NBR) may be substituted if there is a potential of petroleum contaminated soil. Gasket material properties shall be in accordance with AWWA C111.

MATERIAL REQUIREMENTS (Cont):

- **BOLTS AND NUTS:** Bolts and nuts shall be made of high-strength, low-alloy COR-TEN steel. The steel material characteristics and protective coating shall be per AWWA C111 and ASTM 242.
- **CEMENT MORTAR LINING:** Cement mortar lining shall be per AWWA C104, shall be NSF/ANSI 61 approved or compliant, and shall meet the requirements of ASTM C150.
- **CEMENT MORTAR LINING SEAL COAT:** Seal coat shall be per AWWA C104 and qualified in accordance with NSF/ANSI 61.
- **OUTSIDE ASPHALTIC COATING:** Outside asphaltic coating shall be per AWWA C-110 with a minimum applied thickness of 1 mil.

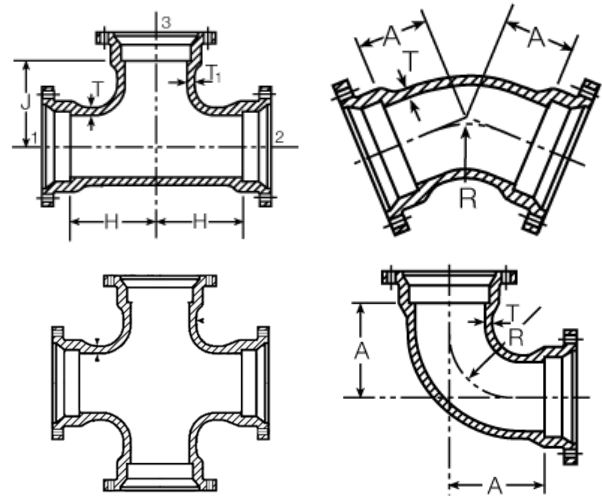

Approved Manufacturers

1. TYLER UNION
2. SIGMA CORPORATION
3. AMERICAN CAST IRON PIPE COMPANY
4. STAR PIPE PRODUCTS

Created: 06/05/13
Revised: 01/06/20

**DUCTILE IRON COMPACT FITTINGS -
MECHANICAL JOINT**

W-9

DESIGN REQUIREMENTS:

- This specification encompasses ductile iron full body mechanical joint fittings for water service, sizes 4" through 36" per AWWA C110.
- Fittings encompassed by this specification shall meet the following minimum working pressure requirements: 4" through 24" - 350 psi, 30" through 36" - 250 psi.
- Fittings shall be UL listed in accordance with NSF/ANSI 61 and be compliant for use in potable water systems.
- Fittings shall conform to AWWA C110 for body thickness and dimensions.
- Dimensions for mechanical joint fitting bells and plain ends, gaskets, and accessories shall conform to AWWA C111.
- Fittings shall be integrally cast with required markings per AWWA C110 and C153.
- Fittings shall be exterior finished with asphaltic coating.
- Fittings shall be cement mortar lined, double thickness for fittings 6" and larger, single thickness for 4", with seal coat.

MATERIAL REQUIREMENTS:

- **DOMESTIC REQUIREMENT:** Ductile iron castings shall be manufactured, assembled, inspected, and packaged in the U.S.A. Contractor's submittals shall include supporting documentation.
- **DUCTILE IRON:** Ductile iron fittings shall be cast using ASTM A536 grade 70-50-05 or 65-45-12 ductile iron.
- **GLANDS:** Ductile iron meeting ASTM A536.
- **GASKETS:** Gaskets shall be suitable for use in potable water systems. Styrene-butadiene rubber (SBR) gaskets shall be standard. Nitrile Buna-N gaskets (NBR) may be substituted if there is a potential of petroleum contaminated soil. Gasket material properties shall be in accordance with AWWA C111.

MATERIAL REQUIREMENTS (Cont):

- **BOLTS AND NUTS:** Bolts and nuts shall be made of high-strength, low-alloy COR-TEN steel. The steel material characteristics and protective coating shall be per AWWA C111 and ASTM 242.
- **CEMENT MORTAR LINING:** Cement mortar lining shall be per AWWA C104, shall be NSF/ANSI 61 approved or compliant, and shall meet the requirements of ASTM C150.
- **CEMENT MORTAR LINING SEAL COAT:** Seal coat shall be per AWWA C104 and qualified in accordance with NSF/ANSI 61.
- **OUTSIDE ASPHALTIC COATING:** Outside asphaltic coating shall be per AWWA C-110 with a minimum applied thickness of 1 mil.

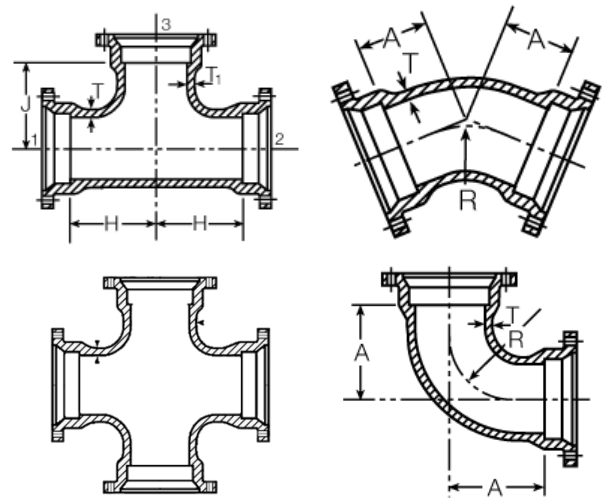

Approved Manufacturers

1. TYLER UNION
2. SIGMA CORPORATION
3. AMERICAN CAST IRON PIPE COMPANY
4. STAR PIPE PRODUCTS

Created: 06/05/13
Revised: 10/01/21

**DUCTILE IRON FULL BODY FITTINGS -
MECHANICAL JOINT**

W-10



CITY OF MESA APPROVED PRODUCTS LIST - WATER

DESIGN REQUIREMENTS:

- This specification encompasses ductile iron full body and compact body unrestrained push-on (PO) fittings for potable water distribution, sizes 4" through 24" per AWWA C110 & AWWA C153.
- Fittings encompassed by this specification shall meet the following minimum working pressure requirements: 4" through 24" - 350 psi.
- Fittings shall be UL listed in accordance with NSF/ANSI 61 and be compliant for use in potable water systems.
- Push-on fittings shall be produced in accordance with the principles specified in AWWA C110 and AWWA C153.
- Push on joint fitting bells, plain ends and gaskets shall conform to the general and performance requirements of AWWA C111.
- Fittings shall be integrally cast with required markings per AWWA C110 and C153.
- Fittings shall be exterior finished with asphaltic coating per AWWA C110 and AWWA C153.
- Fittings shall be cement mortar lined, double thickness for fittings 6" and larger, single thickness for 4", with seal coat, per AWWA C-104 and shall conform to NSF/ANSI 61.
- Plain ends on fittings are specifically not allowed.
- Fittings may have integrally cast restraining lugs. Any joint restraint system utilizing such lugs shall be per the City of Mesa Approved Products List.
- Joints shall be either Tyton or Fastite type.
- This specification does not encompass push-on restrained joint fittings.
- Restraining type gaskets with locking segments are not approved by the City of Mesa for use as a joint restraint method for fittings.

MATERIAL REQUIREMENTS:

- **DOMESTIC REQUIREMENT:** Ductile iron castings shall be manufactured, assembled, inspected, and packaged in the U.S.A. Contractor's submittals shall include supporting documentation.

MATERIAL REQUIREMENTS (Cont):

- **DUCTILE IRON:** Ductile iron fittings shall be cast using ASTM A536 grade 70-50-05 or 65-45-12 ductile iron.
- **GASKETS:** Gaskets shall be suitable for use in potable water systems. Styrene-butadiene rubber (SBR) gaskets shall be standard. Nitrile Buna-N gaskets (NBR) may be substituted if there is a potential of petroleum contaminated soil. Gasket material properties shall be in accordance with AWWA C111.
- **CEMENT MORTAR LINING:** Cement mortar lining shall be per AWWA C104, shall be NSF/ANSI 61 approved or compliant, and shall meet the requirements of ASTM C150.
- **CEMENT MORTAR LINING SEAL COAT:** Seal coat material shall be per AWWA C104 and qualified in accordance with NSF/ANSI 61.
- **OUTSIDE ASPHALTIC COATING:** Outside asphaltic coating shall be per AWWA C-110 with a minimum applied thickness of 1 mil.

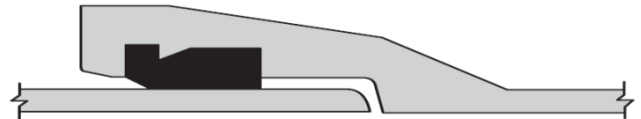

FASTITE JOINT®

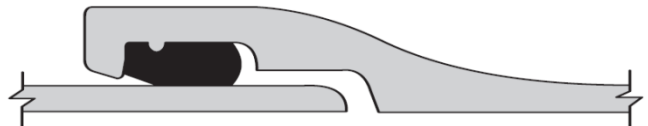

TYTON JOINT®

Approved Manufacturers

1. TYLER UNION
2. SIGMA CORPORATION
3. AMERICAN CAST IRON PIPE COMPANY
4. STAR PIPE PRODUCTS

Created: 06/05/13
Revised: 10/01/21

**DUCTILE IRON FITTINGS - UNRESTRAINED
PUSH ON TYPE**

W-11



CITY OF MESA APPROVED PRODUCTS LIST - WATER

DESIGN REQUIREMENTS:

- This specification encompasses ductile iron flanged joint fittings for water service, sizes 4" through 36" per AWWA C110.
- Fittings encompassed by this specification shall meet the following minimum working pressure requirements: 4" through 36" - 250 psi.
- Fittings shall be UL listed in accordance with NSF/ANSI 61 and be compliant for use in potable water systems.
- Fittings shall conform to AWWA C110 for body thickness and dimensions.
- Flanged fitting joints, gaskets, and accessories shall conform to AWWA C110 & AWWA C111.
- Ductile iron flanges shall be flat faced, without projection.
- Flanges shall conform to AWWA C110 for diameter and thickness and shall be faced and drilled in accordance with ANSI B16.1 Class 125.
- Gaskets shall be one piece, full face. Gasket thickness and dimensions shall be in accordance with AWWA C110 and C111 and shall be rated for a minimum working pressure of 250 psi.
- Gaskets approved for use within flanged joints are listed hereon under Approved Manufacturers.
- Bolts and nuts shall conform to MAG specification section 610 and AWWA C111.
- Bolt size, length, and thread shall be per AWWA C110 and shall conform to ASME/ANSI B18.2.1.
- Nut size and thread shall be per AWWA C110 and shall conform to ASME/ANSI B18.2.2.
- Fittings shall be integrally cast with required markings per AWWA C110.
- Fittings shall be exterior finished with asphaltic coating per AWWA C110.
- Fittings shall be cement mortar lined, double thickness for fittings 6" and larger, single thickness for 4", with seal coat, per AWWA C-104 and shall conform to NSF/ANSI 61.

MATERIAL REQUIREMENTS:

- **DOMESTIC REQUIREMENT:** Ductile iron castings shall be manufactured, assembled, inspected, and packaged in the U.S.A. Contractor's submittals shall include supporting documentation.
- **DUCTILE IRON:** Ductile iron fittings shall be cast using ASTM A536 grade 70-50-05 or 65-45-12 ductile iron.
- **GASKETS:** Gaskets shall be suitable for use in potable water systems and shall be NSF/ANSI 61 compliant. Styrene-butadiene rubber (SBR) gaskets shall be standard. Gasket dimension and material properties shall be in accordance with AWWA C111, ASTM D2000 and/or ASTM D1330. Nitrile Buna-N gaskets (NBR) may be substituted if there is a potential of exposure to petroleum.

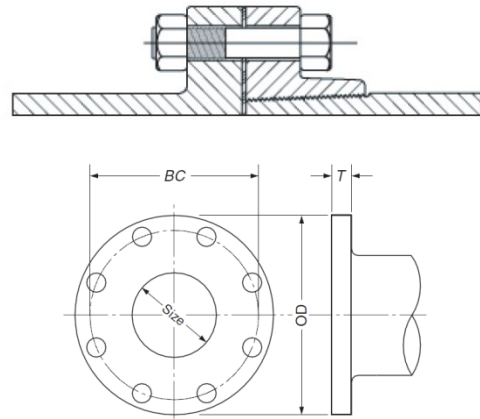

Approved Fitting Manufacturers

1. TYLER UNION
2. SIGMA CORPORATION
3. AMERICAN CAST IRON PIPE COMPANY
4. STAR PIPE PRODUCTS

Approved Gaskets For Flanged Fittings

1. American Toruseal Flange Gasket
2. US Pipe Flange-Tyte
3. Ford Cap Style Flange Gasket – Model CSFG-X

Created: 06/13/13
Revised: 12/29/22

DUCTILE IRON FITTINGS - FLANGED

W-12



CITY OF MESA APPROVED PRODUCTS LIST - WATER

MATERIAL REQUIREMENTS (CONT):

- **BOLTS & NUTS - WATER-DISTRIBUTION MAINS:** The following requirements for bolts and nuts apply to water-distribution pipe and fittings with diameters less than or equal to 16-inches only. All bolts shall be hex-head. Bolts and nuts for buried or above ground service shall conform to one or more of the following:
 - Carbon Steel: ASTM A307 Grade B bolts and ASTM A563 Grade A nuts with hot-dipped zinc coating in accordance with ASTM F2329.*
 - Type 316 Stainless: ASTM F593 bolts and ASTM F594 nuts.*
 - Type 304 Stainless: ASTM A193 B8 Class 2 bolts and ASTM A194 B8 Class 2 nuts.

* See MAG Specification 610.13 for more information.

- **BOLTS & NUTS – WATER TRANSMISSION MAINS AND WATER PRODUCTION OR SUPPLY FACILITIES:** The following requirements for bolts and nuts apply to water pipe and fittings greater than 16-inches in diameter, and pipe and fittings of all diameters for the following: well collection lines and water production or supply facility sites, including well sites, reservoirs, PRV stations, treatment plants, and pump stations. All bolts shall be hex head.

Above Ground:

- Carbon Steel: ASTM A307 bolts and ASTM A563 nuts.**

Buried:

- Type 316 Stainless: ASTM F593 bolts and ASTM F594 nuts.**
- Type 316 Stainless: ASTM A193 bolts and ASTM A194 nuts.**
- Type 304 Stainless: ASTM A193 bolts and ASTM A194 nuts.**

** Bolt and nut grades, classes, mechanical properties, coatings, and other requirements shall be per project specifications as determined by the design engineer for each application. Contractor shall submit for review and approval the selected class, grade, and material properties of bolts and nuts, along with the required application torque. Bolts and nuts shall be selected based upon the required torque value of the flange per the gasket and flange manufacturer requirements.

Submerged:

- Bolt and nut grades, classes, mechanical properties, coatings, and other requirements shall be per project specifications as determined by the design engineer for each application.
- **CEMENT MORTAR LINING:** Cement mortar lining shall be per AWWA C104, shall be NSF/ANSI 61 approved or compliant, and shall meet the requirements of ASTM C150.
- **CEMENT MORTAR LINING SEAL COAT:** Seal coat material shall be per AWWA C104 and qualified in accordance with NSF/ANSI 61.
- **OUTSIDE ASPHALTIC COATING:** Outside asphaltic coating shall be per AWWA C110 with a minimum applied thickness of 1 mil.

Created: 06/13/13 Revised: 12/29/22	DUCTILE IRON FITTINGS - FLANGED	W-12
--	--	-------------

CITY OF MESA APPROVED PRODUCTS LIST - WATER

DESIGN REQUIREMENTS - GENERAL:

- This specification encompasses centrifugally cast ductile iron pipe for water service, sizes 4" through 36" per AWWA C115, C150, and C151.
- Push on and mechanical joint pipe encompassed by this specification shall meet the following minimum working pressure requirements: 4" through 14" - 350 psi, 16" through 36" - 250 psi. Flanged pipe shall be rated for a minimum working pressure of 250 psi.
- Pipe shall be designed in accordance with AWWA C150 and AWWA C115 or AWWA C151. The appropriate thickness class or pressure class shall be determined based upon project specific conditions and requirements. Pipe shall conform to all applicable dimension, thickness, and laying length requirements of AWWA C115, C150, & C151.
- Pipe shall be UL listed, or in accordance with NSF/ANSI 61 for use in potable water systems.
- Pipe shall be integrally cast, or metal stamped, and marked, per AWWA C115 and AWWA C151.
- Pipe shall be exterior finished with asphaltic coating per AWWA C115 or C151.
- Pipe shall be cement mortar lined with seal coat per AWWA C104.

DESIGN REQUIREMENTS - AWWA C115 PIPE:

- Flanged joints, gaskets, bolts, and nuts shall conform to AWWA C111 and AWWA C115.
- Ductile iron flanges shall be flat faced, without projection.
- Flanges shall conform to AWWA C115 for dimension, threading, and material, and shall be faced and drilled in accordance with ASME B16.1 Class 125.
- Flanges shall have an internal taper pipe thread in accordance with ASME B1.20.1.
- Threads on the pipe barrel shall be taper pipe threads per ASME B1.20.1.
- Threaded flanges are to be installed by the pipe manufacturer and shall not be altered or removed by any other party.

MATERIAL REQUIREMENTS:

- **DOMESTIC REQUIREMENT:** Ductile iron castings shall be manufactured, assembled, inspected, and packaged in the U.S.A. Contractor's submittals shall include supporting documentation.
- **DUCTILE IRON:** Centrifugally cast ductile iron pipe shall be cast using, at a minimum, grade 60-42-10 ductile iron. Threaded flanges shall be cast using ASTM A536 Grade 70-50-05 ductile iron. **(Cont. Page 2)**

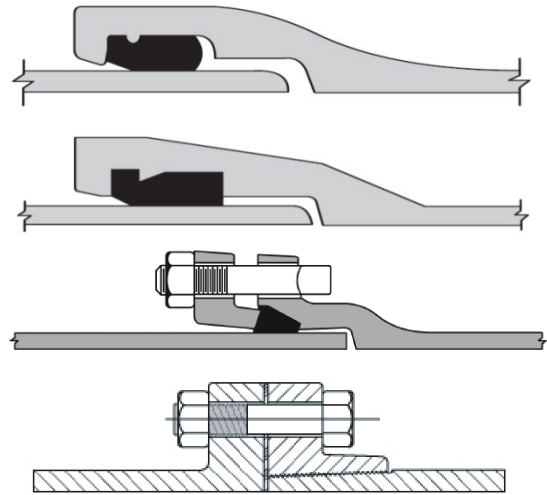

Approved Pipe Manufacturers

1. AMERICAN CAST IRON PIPE
2. MCWANE DUCTILE
3. U.S. PIPE

Approved Pipe Manufacturers - Fabrication

1. U.S. Pipe Fabrication - Type: Flanged
2. Custom Pipe & Fabrication - Type: Flanged
3. Custom Fab – Type: Flanged

Approved Gaskets For Flanged Pipe

1. AMERICAN TORUSEAL FLANGE GASKET
2. US PIPE FLANGE-TYTE
3. Ford Cap Style Flange Gasket – Model CSFG-X

Created: 06/27/13
Revised: 12/29/22

DUCTILE IRON PIPE - CENTRIFUGALLY CAST

W-13



CITY OF MESA APPROVED PRODUCTS LIST - WATER

<p><u>DESIGN REQUIREMENTS - AWWA C115 PIPE(CONT):</u></p> <ul style="list-style-type: none"> • Gaskets shall be one piece, full face. Gasket thickness and dimensions shall be in accordance with AWWA C111 and AWWA C115 and shall be rated for a minimum working pressure of 250 psi. • Gaskets approved for use within flanged joints are listed hereon under <u>Approved Gaskets for Flanged Pipe</u>. • Bolts and nuts shall conform to MAG specification section 610 and AWWA C111. • Bolt size, length, and thread shall be per AWWA C115 and shall conform to ASME/ANSI B18.2.1. • Nut size and thread shall be per AWWA C115 and shall conform to ASME/ANSI B18.2.2. <p><u>DESIGN REQUIREMENTS - AWWA C151 PIPE:</u></p> <ul style="list-style-type: none"> • Push on and mechanical joint pipe bells, plain ends and gaskets shall be in accordance with AWWA C151 and shall conform to the applicable requirements of AWWA C111. • Restraining rings or weld beads utilized in push on or mechanical joint pipe shall be installed by the pipe manufacturer. Field installation of restraining beads or restraining rings is prohibited. • All accessories associated with proprietary push on or mechanical joint restraints shall be in accordance with all applicable AWWA standards. Bolts and nuts utilized in such systems shall, at a minimum, meet the material requirements of this specification. • When considering the use of a proprietary joint restraint system approved under this specification, the contractor and design engineer shall account for limiting factors including, but not limited to, joint deflection and corrosion protection requirements. <p><u>MATERIAL REQUIREMENTS (CONT):</u></p> <ul style="list-style-type: none"> • GASKETS: Gaskets shall be suitable for use in potable water systems and shall be NSF/ANSI 61 compliant. Styrene-butadiene rubber (SBR) gaskets shall be standard. Gasket dimension and material properties shall be in accordance with AWWA C111 or C115, ASTM D2000 and/or ASTM D1330. Nitrile Buna-N gaskets (NBR) may be substituted if there is a potential of exposure to petroleum. 	<p><u>MATERIAL REQUIREMENTS (CONT):</u></p> <ul style="list-style-type: none"> • FLANGE BOLTS & NUTS - WATER-DISTRIBUTION MAINS: The following requirements for bolts and nuts apply to water-distribution pipe and fittings with diameters less than or equal to 16-inches only. All bolts shall be hex-head. Bolts and nuts for buried or above ground service shall conform to one or more of the following: <ul style="list-style-type: none"> ○ Carbon Steel: ASTM A307 Grade B bolts and ASTM A563 Grade A nuts with hot-dipped zinc coating in accordance with ASTM F2329.* ○ Type 316 Stainless: ASTM F593 bolts and ASTM F594 nuts.* ○ Type 304 Stainless: ASTM A193 B8 Class 2 bolts and ASTM A194 B8 Class 2 nuts. <p>* See MAG Spec. 610.13 for more information.</p> • FLANGE BOLTS & NUTS – WATER TRANSMISSION MAINS AND WATER PRODUCTION OR SUPPLY FACILITIES: The following requirements for bolts and nuts apply to water pipe and fittings greater than 16-inches in diameter, and pipe and fittings of all diameters for the following: well collection lines and water production or supply facility sites, including well sites, reservoirs, PRV stations, treatment plants, and pump stations. All bolts shall be hex head. <p><u>Above Ground:</u></p> <ul style="list-style-type: none"> ○ Carbon Steel: ASTM A307 bolts and ASTM A563 nuts.** <p><u>Buried:</u></p> <ul style="list-style-type: none"> ○ Type 316 Stainless: ASTM F593 bolts and ASTM F594 nuts.** ○ Type 316 Stainless: ASTM A193 bolts and ASTM A194 nuts.** ○ Type 304 Stainless: ASTM A193 bolts and ASTM A194 nuts.** <p>** Bolt and nut grades, classes, mechanical properties, coatings, and other requirements shall be per project specifications as determined by the design engineer for each application. Contractor shall submit for review and approval the selected class, grade, and material properties of bolts and nuts, along with the required application torque. Bolts and nuts shall be selected based upon the required torque value of the flange per the gasket and flange manufacturer requirements.</p>
---	---

Created: 06/27/13
Revised: 12/29/22

DUCTILE IRON PIPE - CENTRIFUGALLY CAST

W-13



CITY OF MESA APPROVED PRODUCTS LIST - WATER

<p><u>MATERIAL REQUIREMENTS (CONT):</u></p> <ul style="list-style-type: none">• FLANGE BOLTS & NUTS – WATER TRANSMISSION MAINS AND WATER PRODUCTION OR SUPPLY FACILITIES (CONT): <u>Submerged:</u><ul style="list-style-type: none">○ Bolt and nut grades, classes, mechanical properties, coatings, etc. shall be per project specs as determined by the design engineer for each application.• MECHANICAL JOINT (MJ) BOLTS AND NUTS: Bolts and nuts shall be made of high-strength, low-alloy COR-TEN steel. The steel material characteristics and protective coating shall be per AWWA C111 and ASTM 242.• CEMENT MORTAR LINING: Cement mortar lining shall be per AWWA C104, shall be NSF/ANSI 61 approved or compliant, and shall meet the requirements of ASTM C150.• CEMENT MORTAR LINING SEAL COAT: Seal coat material shall be of asphaltic material per AWWA C104 and qualified in accordance with NSF/ANSI 61.• OUTSIDE ASPHALTIC COATING: Outside asphaltic coating shall be per AWWA C115 or C151 with a minimum applied thickness of 1 mil.		
Created: 06/27/13 Revised: 12/29/22	DUCTILE IRON PIPE - CENTRIFUGALLY CAST	W-13

CITY OF MESA APPROVED PRODUCTS LIST - WATER

DESIGN AND SELECTION REQUIREMENTS:

- This specification encompasses wedge type locking gaskets for use in restraining push-on ductile iron pipe for water service, sizes 4" through 16".
- Push-on joint locking gaskets encompassed by this specification shall meet the following minimum working pressure requirement: 350 psi.
- Locking gaskets shall meet the design, material, performance, testing, and other applicable requirements of AWWA C111.
- Locking gaskets shall be NSF/ANSI 61 approved or compliant for use in potable water systems.
- Gaskets shall have integrally vulcanized/molded stainless steel gripping wedges/inserts.
- When locking gaskets are installed on cut pipe, the cut end must be properly prepared. A smooth assembly chamfer or bevel, free from sharp edges or burs, shall be ground onto the cut end of the pipe per gasket manufacturer's requirements.
- Deflection requirements, from an installation standpoint, differ by manufacturer. Gaskets shall be selected that meet the deflection requirement and intended installation method of the project application.

RESTRICTIONS:

- Locking gaskets shall not be used in above ground applications.
- Gaskets encompassed by this specification are specifically not approved for use on fittings or plugs and shall not be utilized on pipe within a casing.
- Locking gaskets shall not be utilized on corroded or gray iron pipe and shall not be reused if removed.
- When specifying the use of locking gaskets with stainless steel wedges, the corrosion protection system design of the pipeline shall be considered. Integral wedges shall not be considered as an acceptable method of obtaining continuity between pipe segments. Conversely, if pipe segments require discontinuity integral to the corrosion system design, steel inserted gaskets may not be appropriate.

RESTRICTIONS (Cont):

- Care shall be taken in the selection of locking gaskets as joint dimensions may differ. Fast Grip gaskets shall only be installed in Fastite bell joints. Barracuda, Gripper, Sure Stop 350, Piranha, and Field Lok 350 shall only be installed in Tyton bell joints.

MATERIAL REQUIREMENTS:

- **GASKETS:** Gaskets shall be suitable for use in potable water systems and shall be NSF/ANSI 61 certified or compliant for water service. Styrene-butadiene rubber (SBR) gaskets shall be standard. Gasket dimension and material properties shall be in accordance with applicable standards: AWWA C111, ASTM D2000 and/or ASTM D1330.
- **GRIPPING WEDGE INSERTS:** Gripping wedge inserts shall be manufactured of high strength stainless steel.

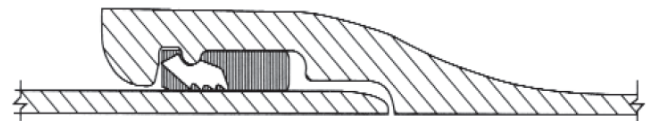

TYTON JOINT®

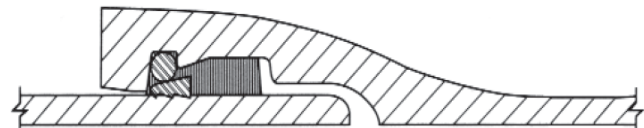

FASTITE JOINT®

Approved Manufacturers

1. FAST-GRIP - AMERICAN CAST IRON PIPE
2. BARRACUDA – SPECIFICATION RUBBER PROD.
3. GRIPPER GASKET LLC - GRIPPER GASKET
4. SURE STOP - MCWANE DUCTILE
5. PIRANHA - ROMAC INDUSTRIES
6. FIELD LOK 350 - U.S. PIPE

Created: 09/30/13
Revised: 01/03/19

**INTEGRAL WEDGE TYPE LOCKING GASKETS FOR
DUCTILE IRON PIPE WITH PUSH-ON JOINTS**

W-14

CITY OF MESA APPROVED PRODUCTS LIST - WATER

DESIGN REQUIREMENTS:

PIPE RESTRAINT HARNESS (NEW PIPE):

- Ductile iron pipe bell restraints shall consist of wedge-action restraint rings on spigots joined to ductile iron backup rings behind the bells.
- Minimum Pressure Ratings and Thrust Rod Requirements:

Diameter	Min. Pressure Rating*	Min. # Thrust Rods	Min. Thrust Rod Dia.
○ 3"	350 psi	4	5/8"
○ 4"	350 psi	4	5/8"
○ 6" thru 8"	350 psi	6	5/8"
○ 10" thru 14"	350 psi	8	3/4"
○ 16" thru 18"	350 psi	10	3/4"
○ 18"	250 psi	10	3/4"
○ 20"	250 psi	12	3/4"
○ 24"	250 psi	14	3/4"
○ 30"	250 psi	16	1"
○ 36"	250 psi	20	1"

*With 2:1 safety factor.

BELL RESTRAINT HARNESS (EXISTING PIPE):

- Split ductile-iron restraint rings incorporating a plurality of individually-actuating gripping surfaces, shall be used to grip the pipe on either side of the bell, and a sufficient number of rods shall be used to connect each restraint to one another.
- Minimum Pressure Ratings and Thrust Rod Requirements:

Diameter	Min. Pressure Rating*	Min. # Thrust Rods	Min. Thrust Rod Dia.
○ 3"	350 psi	4	5/8"
○ 4" thru 8"	350 psi	4	3/4"
○ 10" thru 12"	300 psi	4	3/4"
○ 14"	300 psi	6	3/4"
○ 16"	300 psi	8	3/4"
○ 18"	200 psi	8	3/4"
○ 20"	200 psi	10	3/4"
○ 24"	200 psi	12	3/4"
○ 30"	200 psi	16	1"
○ 36"	200 psi	20	1"

*With 2:1 safety factor.

Pipe Bell Restraints (new pipes)

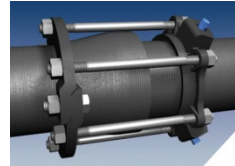

EBAA MegaLug Series 1700

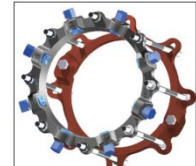

Stargrip Series 3100P



Ford Uni-Flange Series 1450



Ford Uni-Flange Series 1455

Split Bell Restraints (new or exist. pipes)

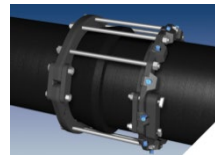

EBAA MegaLug Series 1100HD



Ford Uni-Flange Series 1490

Approved Models (new pipes):

1. EBAA MEGALUG SERIES 1700 (Domestic Only)
SIZES: 3"-36", #1703 thru #1736
2. STAR PIPE STARGRIP SERIES 3100P (Domestic Only)
SIZES: 3"-12", 16" and 24", #SGDPGF03D thru #SGDPGF12D, #SGDPGF16D, and #SGDPGF24D.
3. FORD UNI-FLANGE SERIES 1450 (Domestic Only)
SIZES: 3"-36", #UFR1450-D-3-U thru #UFR1450-D-36-U
4. FORD UNI-FLANGE SERIES 1455 (Domestic Only)
SIZES: 14"-36", #UFR1455-D-14-U thru #UFR1455-D-36-U

Approved Models (new / exist. pipes):

(see next page)

Created: 09/30/13
Revised: 09/30/14

JOINT RESTRAINTS FOR DUCTILE IRON PIPE WITH PUSH-ON JOINTS

W-15



CITY OF MESA APPROVED PRODUCTS LIST - WATER

<p>COMMON REQUIREMENTS – PIPE AND BELL RESTRAINT HARNESSSES:</p> <ul style="list-style-type: none"> • Restraint rings shall have individually actuated wedges that increase their resistance to pull-out as pressure or external forces increase. • Torque limiting twist off nuts shall be used to insure proper actuation of the restraining wedges. • Joint restraints shall utilize conventional tools and installation procedures per AWWA C600. • Restraint glands shall restrain pipe conforming to the requirements of ANSI/AWWA C151/A21.51. <p><u>MATERIALS:</u></p> <ul style="list-style-type: none"> • <u>RESTRAINT RING AND WEDGE COMPONENTS:</u> Minimum grade 65-45-12 ductile iron conforming to ASTM A536. • <u>WEDGES:</u> Ductile iron heat treated to a minimum hardness of 370 BHN. • <u>SPLIT RINGS:</u> minimum grade of 65-45-12 ductile iron conforming to ASTM A536. • <u>CONNECTING TIE RODS AND HEX NUTS:</u> Low alloy steel conforming to ANSI/AWWA C111/A21.11. • <u>COATING:</u> Restraint bodies, wedge assemblies and related components shall be coated with a fusion-bonded or electrostatically-applied heat-cured epoxy coating. • <u>BOLTS, NUTS, & GASKETS:</u> Domestic or non-domestic bolts, nuts, and gaskets are acceptable provided they are manufacturer packaged with the pipe restraint harness. • <u>DOMESTIC IRON REQUIREMENT:</u> Ductile iron castings shall be manufactured, assembled, inspected, and packaged in the U.S.A. Contractor’s submittals shall include supporting documentation. 	<p><u>NOTES:</u></p> <ol style="list-style-type: none"> 1. Approved models are only for use on ductile-iron pipe. Restraints are not allowed for use on plain-end fittings, gray-iron pipe, PVC or HDPE. 2. Restraints shall be colored black or blue only. 3. Referenced standards reflect the latest revision. 4. Restraints shall be adequately wrapped or protected if they are covered by concrete to ensure that concrete does not enter the wedge pockets. 5. Restraints are not to be used for applications with vertical offsets. 6. For installations on existing pipe, the pipe shall be structurally sound and the surface free of any corrosive by-products in order for the wedges to function properly. 7. Installations shall maintain adequate clearance between outside diameters of pipe bells and restraining rods, accounting for joint deflection as applicable. 	
<p>Created: 09/30/13 Revised: 09/30/14</p>	<p>JOINT RESTRAINTS FOR DUCTILE IRON PIPE WITH PUSH-ON JOINTS</p>	<p>W-15</p>
<p>Approved Models (new / exist. pipes):</p> <ol style="list-style-type: none"> 1. EBAA MEGALUG SERIES 1100HD (Domestic Only) SIZES: 3"-36", #1103HD thru #1136HD 2. FORD UNI-FLANGE SERIES 1490 (Domestic Only) SIZES: 14"-36", #UFR1490-D-14-U thru #UFR1490-D-36-U 		

CITY OF MESA APPROVED PRODUCTS LIST - WATER

DESIGN:

- This specification encompasses bolted sleeve type unrestrained couplings for plain end pipe up to 16 inches in diameter and designed for use on pressurized cast iron pipe, ductile iron pipe, and asbestos-cement pipe for potable water service for leak repairs or joining two plain end pipes of dissimilar or similar diameters.
- Couplings shall conform to the requirements of AWWA C219, latest edition.
- Couplings shall be certified to, or compliant with, NSF/ANSI Standard 61.
- Couplings encompassed by this specification shall meet or exceed the minimum working pressure of 150 psi and shall be designed to withstand a minimum test pressure of 1.5 times working pressure, per AWWA C219.
- Minimum center sleeve lengths shall be per AWWA C219, Table 2.
- Sleeve type couplings listed hereon do not provide joint restraint. Installations shall incorporate joint restraint provisions per MAG and City of Mesa specifications.
- Couplings shall be designed to allow for a minimum of 3 degrees of angular deflection per end.
- All interior and exterior sleeve and end ring surfaces shall be epoxy coated.

MATERIALS:

- **CENTER SLEEVE:** Carbon steel per AWWA C219, or ductile iron per ASTM A536, grade 65-45-12.
- **END RINGS:** Carbon steel per AWWA C219, or ductile iron per ASTM A536, grade 65-45-12.
- **COATING:** Interior and exterior fusion-bonded epoxy coating certified to, or compliant with, the requirements of NSF/ANSI 61.
- **GASKETS:** Gaskets shall be SBR, EPDM, or NBR conforming to the requirements of ASTM D2000. Gaskets shall conform to, or be certified to, NSF/ANSI 61 and shall be suitable for use in potable water systems with temperatures up to 150° F.
- **BOLTING MATERIALS:** Galvanically compatible materials shall be used for bolts, nuts, and washers to minimize the possibility of corrosion and shall be supplied by the coupling manufacturer.



Krausz Hymax



Smith Blair 413, 461, 462



Cascade Omega



Ford FC1 & FC2 Series

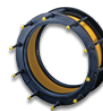

Romac 400/TC400

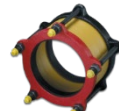

Romac 501



Romac Macro HP



JCM 201



JCM 241



JCM 242

Approved Models:

1. KRAUSZ HYMAX 860 & 862 (4" thru 16")
2. SMITH BLAIR 413 (4" THRU 16")
3. SMITH BLAIR 461, 462 QUANTUM (4" THRU 12")
4. FORD FC1 (4" THRU 12", EPOXY COATED WITH -ESH SUFFIX ONLY)
5. FORD FC2 (4" THRU 16", EPOXY COATED WITH -ESH SUFFIX ONLY)
6. CASCADE OMEGA CR CER (4" THRU 12")
7. ROMAC 501 (4" THRU 16")
8. ROMAC 400/TC400 (12" THRU 16")
9. ROMAC MACRO HP (4" THRU 12")
10. JCM 201 – FOR STEEL PIPE ONLY (4" THRU 16" E OR ES MODELS ONLY)
11. JCM 241 STD LENGTH (4" THRU 16" E OR ES MODELS ONLY)
12. JCM 242 LONG LENGTH (4" THRU 16" E OR ES MODELS ONLY)

Created: 09/30/13
Revised: 07/01/20

**BOLTED SLEEVE-TYPE COUPLINGS FOR PLAIN-
END PIPE**

W-16



CITY OF MESA APPROVED PRODUCTS LIST - WATER

MATERIALS (Cont):

- **BOLTS:** Bolts shall be stainless steel or steel per the following:
 - Type 304 stainless steel meeting or exceeding the requirements of ASTM F593 or F738M, coated to prevent galling.
 - Steel meeting or exceeding the requirements of AWWA C219. Steel bolts shall be manufacturer plated or coated to inhibit corrosion.
- **NUTS:** Nuts shall be stainless steel or steel per the following:
 - Type 304 stainless steel meeting or exceeding the requirements of ASTM F594 or F836M, coated to prevent galling.
 - Steel meeting or exceeding the requirements of AWWA C219. Steel bolts shall be manufacturer plated or coated to inhibit corrosion.

Created: 09/30/13
Revised: 07/01/20

**BOLTED SLEEVE-TYPE COUPLINGS FOR PLAIN-
END PIPE**

W-16

CITY OF MESA APPROVED PRODUCTS LIST - WATER

DESIGN REQUIREMENTS:

- This specification encompasses full-encirclement repair clamps for water service, sizes 1/2" through 16". The intent of this specification is to cover repairs to existing, in service pipes only, for diameters 16" and under.
- Repair clamps shall conform to AWWA C230, latest edition, and shall meet or exceed the requirements of NSF-61 and NSF-372, and the Safe Drinking Water Act.
- Repair clamps shall be of all stainless steel design with fully passivated welds.
- Clamps shall have a 360-degree elastomeric seal with integrated attachment lug and bolting system.
- Clamps shall be designed to prevent contact between stainless-steel bands and ferrous pipe materials upon installation.
- Repair clamps shall be rated for 150 psig minimum working pressure.
- Optional service connection outlets shall conform to AWWA C800, latest edition.

MATERIAL REQUIREMENTS:

- CLAMP BANDS: ASTM A240 type 304 stainless steel.
- LUGS: Type 304 stainless-steel per ASTM A240, A743/A743M, or ASTM A744/744M.
- GASKETS: Gaskets shall be SBR, EPDM, or NBR per ASTM D2000, must comply with NSF-61 requirements, and be suitable for water service temperatures of up to 100° F.
- BOLTS: Bolts shall be type 304 stainless steel meeting or exceeding the requirements of ASTM F593, ASTM F738M, or ASTM A193*.
- NUTS: Nuts shall be type 304 stainless steel meeting or exceeding the requirements of ASTM F594, ASTM F836M, or ASTM A194*.
 - *Coated with anti-seize lubricant to prevent galling.
- OPTIONAL SERVICE CONNECTION OUTLETS: Meeting or exceeding ASTM A276.

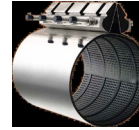

Krausz Hymax Clamp



Ford FS1 & FS2



Romac SS1 & SS2



Romac SS3



Romac SL1 & SL2



Romac SCC



Romac SCS



JCM 111 AS



JCM 131 & 132



JCM 161 & 162

Approved Models:

1. KRAUSZ HYMAX CLAMP (3" THRU 12")
2. FORD FS1 (2" THRU 12")
3. FORD FS2 (4" THRU 16")
4. ROMAC SS1 (2" THRU 12")
5. ROMAC SS2 (4" THRU 14")
6. ROMAC SL1/SL2 (4" THRU 12")
7. ROMAC SCC/SCS (1/2" THRU 2")
8. JCM 111-AS (1/2" THRU 2")
9. JCM 131 STD RNG (1-1/2" THRU 12")
10. JCM 132 EXT RNG (4" THRU 16")
11. JCM 161 STD RNG (2" THRU 12")
12. JCM 162 EXT RNG (4" THRU 16")

Created: 9/30/13
Revised 01/03/19

**FULL-ENCIRCLEMENT REPAIR CLAMPS FOR
WATER SERVICE**

W-17

DESIGN REQUIREMENTS:

- This specification encompasses bell joint leak clamps for water service, sizes 4” through 16”. The intent of this specification is to cover repairs to existing in service pipes only, for diameters 16” and under.
- Bell joint leak clamps shall be designed to provide a means of repairing or preventing leaks in cast iron bells, and caulked or rubber ring joints by means of packing a gasket against the joint face.
- Clamps shall be designed to fit both caulked and rubber ring joints for most classes of cast iron and ductile iron pipe of nominal sizes.
- Bell joint leak clamps shall conform to the requirements of NSF-61 and NSF-372.

MATERIAL REQUIREMENTS:

- **BELL AND SPIGOT RING:** The body bell and spigot rings shall be ductile iron per ASTM A536.
- **COATING:** Ductile iron bell and spigot rings shall be manufacturer coated with epoxy.
- **GASKETS:** Gaskets shall be SBR, EPDM, or NBR per ASTM D2000, must comply with NSF-61 requirements, and be suitable for water service temperatures up to 100° F.
- **BOLTS & NUTS:** Bolts shall be type 304 stainless steel meeting or exceeding ASTM F593, ASTM F738M, or ASTM A193, coated with anti-seize lubricant to prevent galling, or high strength, low alloy steel per ASTM A242, ASTM A307, or AWWA C111.



Ford FBC



Romac 516



Smith Blair 274



JCM 143

Approved Models:

1. FORD FBC (4” THRU 12”)
2. ROMAC 516 (4” THRU 14”)
3. SMITH BLAIR 274 (4” THRU 16”)
4. JCM 143 (4” THRU 12”)

Created: 9/30/13
Revised:12/18/14

BELL JOINT LEAK CLAMPS FOR WATER SERVICE

W-18

CITY OF MESA APPROVED PRODUCTS LIST - WATER

DESIGN REQUIREMENTS:

- This specification encompasses insertion valves for water service, sizes 4” through 16”. The intent of this specification is to cover valve insertion for existing, in service pipes only.
- Valves shall be resilient wedge type, and conform to AWWA C509 or AWWA C515, latest edition.
- Valve assemblies shall be certified to, or compliant with, NSF-61 and NSF-372.
- Insertion valve assemblies shall be rated for a minimum working pressure of 250 psig.
- Insertion valve design shall allow the valve to be installed into an existing pressurized pipeline while maintaining constant pressure.
- Valve body assemblies shall be of two piece design, with a removable valve bonnet for valve maintenance and repair.
- Valves shall be of the non-rising stem type and shall be counter clockwise opening.
- Insertion valves shall have a 2” square operating nut for buried service.
- Valves shall not be installed in the horizontal position without prior written approval by the City of Mesa Water Resources Department.
- For valve box installation see Approved Products List sheet W-4, Gate Valves.
- Valve assemblies shall be factory epoxy coated.

MATERIAL REQUIREMENTS:

- VALVE BODY & BONNET: Ductile iron per ASTM A536, grade 65-45-12.
- WEDGE: Fully rubber encapsulated ductile iron per ASTM A536, and AWWA C509.
- COPPER ALLOYS: Copper alloys shall conform to the requirements of AWWA C509 & AWWA C515. Copper alloys in contact with drinking water shall conform to the Safe Drinking Water Act.

MATERIAL REQUIREMENTS (Cont):

- GASKETS: O-rings and gaskets shall be suitable for use in potable water systems and shall meet the requirements of AWWA C509 & C515.
- COATINGS: Interior and exterior ferrous surfaces shall be factory applied epoxy coated to a minimum dry film thickness of 8 mils per AWWA C550 and shall conform the NSF-61 requirements.
- BOLTS AND NUTS: Bolts and nuts shall conform to the requirements of AWWA C509 or AWWA C515.

INSTALLATION REQUIREMENTS:

- Installation shall be completed by certified and approved installers only. Contractor shall submit installer credentials for review and written approval prior to installation.



AVT EZ Valve



Occlude Insert Valve



Mueller Permaseal

Approved Models:

1. OCCLUDE INSERT VALVE (4” - 8”)
2. AVT EZ VALVE (4” - 16”)
3. MUELLER PERMASEAL H-2361 (4” - 12”)

Created: 10/1/13
Revised: 01/03/22

INSERTION VALVES

W-19

CITY OF MESA APPROVED PRODUCTS LIST - WATER

DESIGN REQUIREMENTS - GENERAL:

- This specification encompasses potable water meter assembly appurtenances for above-ground non-fire rated meter sizes 4" and 6" per City of Mesa Standard details M-27.02, M-28.01.
- All components in contact with potable water shall be certified to ANSI/NSF 61 standards and compliant with ANSI/NSF 372 standards for lead content.
- Materials shall comply with the Safe Drinking Water Act.

DESIGN REQUIREMENTS - STRAINERS:

- Strainers encompassed by this specification shall meet or exceed the minimum required operating pressure of 150 psi.
- Strainers encompassed by this specification shall meet or exceed the requirements of AWWA C702 and shall have an effective straining area of at least double that of the main-case water inlet.
- Strainer screens/plates shall be removable for maintenance without removing the strainer assembly.
- Strainers shall be supplied with round flanges, faced, and drilled, meeting the requirements of AWWA C701 or AWWA C702, as applicable.
- Strainer maximum screen/plate perforation sizing shall be 3/16" for 4" meters and 1/4" for 6" meters.

MATERIAL REQUIREMENTS - STRAINERS:

- HOUSING COVER & CASING: Lead free copper alloy containing not less than 75% copper per AWWA C702, certified to ANSI/NSF 61, and compliant with ANSI/NSF 372.
- SCREEN/PLATE: Stainless steel type 304 or type 316 per ASTM A240 and AWWA C702.
- FASTENERS: Housing bolts shall be type 304 or type 316 stainless steel.



Badger Meter – Copper Alloy Plate Strainer



Neptune Technology Group – Copper Alloy Plate Strainer

Strainers - Approved Models:

1. BADGER METER:
4" MODEL – 100-6312
6" MODEL – 100-6146
2. NEPTUNE TECHNOLOGY GROUP:
4" MODEL – 53107-100
6" MODEL – 52000-201

Created: 09/01/21
Revised: 10/01/21

**WATER METER ASSEMBLY
APPURTENANCES**

W-20

REQUIREMENTS - GENERAL:

- This specification encompasses corrosion protection products for buried ductile iron pipe and fittings including polyethylene wrap, bolt covers, and flange isolation components. This specification is limited in scope to the most commonly used corrosion protection products and is not intended to cover all components which may be required for corrosion protection systems as designed for project specific conditions.

REQUIREMENTS - POLYETHYLENE ENCASEMENT:

- Unless otherwise indicated by project specific conditions, including soils testing indicating non-corrosive soils, ductile iron pipe, valves, and fittings shall be protected from corrosion by encasement in a polyethylene protective wrapping.
- Polyethylene encasement for ductile iron pipe systems shall be per AWWA C105, latest edition, MAG Specification section 610, latest edition, and the City of Mesa amendments thereof.
- Polyethylene wrap shall be manufactured from virgin polyethylene material, shall be not less than 8 mils in thickness, and shall be weather resistant black, containing not less than 2 percent stabilized carbon black.
- Polyethylene film for pipe and fittings shall be of tube type, with minimum flat tube width per MAG Specification section 610.
- Polyethylene film shall be marked per AWWA C105.
- Polyethylene wrap shall be secured with 2-inch wide pressure tape conforming to MAG Specification section 610.
- Polyethylene wrap shall be installed per AWWA C105 and MAG Specification section 610.

REQUIREMENTS - POLYETHYLENE BOLT & NUT CAPS:

- The following requirements for the selection and installation of polyethylene bolt and nut caps apply only to bolted flanged pipe or fittings greater than 16-inches in diameter, or flanged pipe and fittings of all diameters for well collection lines and water production or supply facility sites, including well sites, reservoir sites, PRV stations, treatment plants, and pump stations, or per project specific conditions and requirements.
- Unless otherwise indicated by project specific conditions, bolt & nut protective caps shall be constructed of low-density polyethylene, the color shall be black, and shall be snap on type.
- Protective caps shall be installed with corrosion inhibiting synthetic grease per manufacturer's recommendations.
- Corrosion inhibiting grease shall be nontoxic, shall not degrade polyethylene, and shall be FDA approved for use in potable water systems.

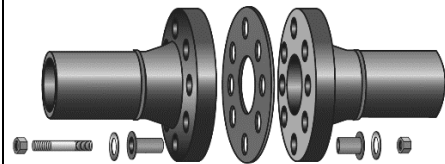
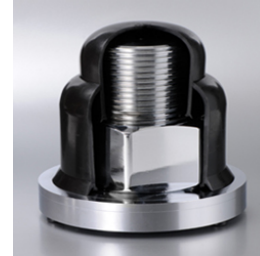

Approved Manufacturer/Vendor:

Polyethylene Encasement

1. TRUMBULL MANUFACTURING
2. CHRISTY'S
3. INFINITY PLASTICS
4. NORTHTOWN COMPANY
5. AA THREAD SEAL TAPE, INC

Bolt & Nut Caps

1. APS
2. DRAKE SPECIALTIES
3. SAP-SEAL PRODUCTS

Flange Isolation Kits (Type E)

1. APS
2. DRAKE SPECIALTIES
3. LAMONS
4. GPT INDUSTRIES
5. LONESTAR

Created: 09/30/14
Revised: 10/01/21

**CORROSION PROTECTION FOR BURIED
DUCTILE IRON PIPE AND FITTINGS**

W-21



CITY OF MESA APPROVED PRODUCTS LIST - WATER

REQUIREMENTS – FLANGE ISOLATION COMPONENTS:

- Where dissimilar metals are joined at flanged connections, or where flanged joints shall be cathodically isolated, flange isolation kits shall be provided.
- Flange isolation kits shall be of the double isolation type and shall consist of a full faced gasket, a full length sleeve for each bolt, and two isolating washers with two steel backup washers for each bolt.
- Flange isolation kits shall be supplied in complete sets from a single supplier, and the material and mechanical properties of the components shall be suitable for service at the operating temperatures and pressure requirements of the specific project conditions. The complete assembly shall have an ANSI pressure rating equal to that of the flanged joint where it is installed.
- Unless otherwise indicated by project specific pressure, temperature, and dielectric requirements, isolation kit components shall meet the following minimum requirements:
- ISOLATION GASKET: Gaskets shall be full faced type E and 1/8" thick. Acceptable materials are neoprene faced phenolic, G-10, or non-asbestos blended aramid fiber with NBR elastomer. Elastomer sealing rings in isolation retainers shall be nitrile or EPDM. All gaskets shall be suitable for use in potable water systems and shall be NSF/ANSI 61 certified or compliant.
- ISOLATION SLEEVES: Sleeves shall be full length and 1/32" minimum thickness. Sleeves may be provided as a one piece isolation sleeve and washer. Acceptable materials are LE phenolic, G-10, mylar, or Nomex.
- ISOLATION WASHERS: Isolation washers shall be designed to fit over the isolating sleeve and the isolating and steel backing washer shall have the same inside and outside diameters. Isolation and backing washers shall be 1/8" minimum thickness. Acceptable materials are fabric reinforced phenolic or G-10. Steel backing washers shall be zinc coated steel.

Created: 09/30/14
Revised: 10/01/21

**CORROSION PROTECTION FOR BURIED
DUCTILE IRON PIPE AND FITTINGS**

W-21

CITY OF MESA APPROVED PRODUCTS LIST - WATER

REQUIREMENTS - GENERAL:

- This specification encompasses water main casing products for ductile iron pipe installed in casing pipe, including casing spacers and end seals. This specification is limited in scope to water main installations for ductile iron pipe sizes up to and including 16-inches. For water main sizes greater than 16-inches installed in casing pipe, special submittal of casing spacer and end seal specifications is required.
- When carrier and casing pipe is installed in applications where potential excessive moisture or corrosive soil is present, in conditions of heavy loading, or in areas with potential submergence or electrical influence, alternative types of casing, casing spacers, and end seals may be required per project plans and specifications, and require written approval by the City of Mesa Water Resources Department.
- All water mains installed in casing pipe shall be fully restrained using joint restraint products and methods per Approved Products List.
- Water mains shall be installed in casing pipe in the standard unrestrained or centered unrestrained positions (see diagrams at right), which prevents the transference of potential casing load to the water main.

REQUIREMENTS – CASING SPACERS:

- Casing spacers shall be designed to carry restrained ductile iron pipe, with any associated appurtenances, under operational conditions and without the casing annular space being grouted or otherwise filled.
- Casing spacers shall be installed in intervals not less than that specified in MAG Standard Specifications section 602. Project specific conditions, or manufacturer recommendation, may require a shorter maximum spacing distance.
- Casing spacers shall be provided in a symmetrical runner configuration to accommodate the potential of rifling during installation.
- Submittals for casing spacers shall include the proposed spacing, the band and riser material and gauge, the runner material and size, the liner material and thickness, and fastener material. Submittals shall also indicate that the casing spacers have been selected for the correct pipe material and casing installation distance.
- **BAND:** Casing spacer bands shall be type 304 stainless steel with a minimum steel thickness of 14 gauge. The minimum allowable band width is 8-inches. Welds shall be passivated.
- **RISER:** Risers shall be type 304 stainless steel with a minimum steel thickness of 10 gauge.
- **RUNNER:** Runners shall be glass reinforced polymer or HDPE, and shall have a minimum width of 2-inches.
- **LINER/INSULATOR:** Liner material shall be PVC or EPDM with a minimum thickness of 0.09-inches.
- **FASTENERS:** Fasteners shall be type 304 stainless steel.

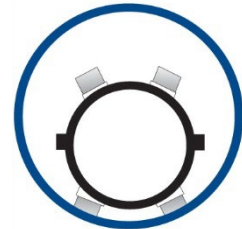

Standard Unrestrained Position

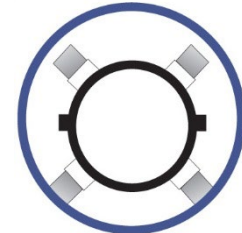

Centered Unrestrained Position

Approved Manufacturer/Vendor:

Casing Spacers

1. APS: SSI8 OR SSI12
2. BWM: SS-8 OR SS-12
3. CALPICO: M-8-SS OR M-12-SS
4. CASCADE: TYPE CCS
5. CCI: CSS8 OR CSS12
6. GPT: MODEL S

Casing End Seals

1. APS: AC OR AM
2. BWM: BWM-PO
3. CALPICO: MODEL C
4. CASCADE: MODEL CCES
5. CCI: MODEL ESC
6. GPT: TYPES C OR R

Created: 09/30/14
Revised: 01/03/19

WATER MAIN CASING APPURTENANCES

W-22



CITY OF MESA APPROVED PRODUCTS LIST - WATER

REQUIREMENTS – CASING END SEALS:

- Casing end seals shall be selected to accommodate the specific conditions of each installation and shall not promote electrical continuity between the carrier pipe and casing.
- Unless otherwise indicated by project specific conditions, casing end seals shall be of seamless one-piece design and shall be affixed to the carrier pipe and casing utilizing stainless steel bands.
- **END SEAL DESIGN:** End seal size shall be selected based upon the specific configuration of the carrier pipe whether eccentric, or concentric. End seals shall be sized correctly to provide a tight seal on casing and carrier pipes. For all new installations, end seals shall be of seamless design. Wrap around or zipper end seals may be considered on a case by case basis, with Water Resources approval. End seals shall be of molded or folded pull on types.
- **END SEAL MATERIAL:** End seals shall be of synthetic rubber compounds suitable for the project environmental conditions. Compounds may be neoprene, SBR, or EPDM, or as indicated by project plans and specifications. Minimum material thickness shall be 1/8-inch.
- **RETAINING BANDS:** Retaining bands shall be of all stainless steel design, type 304, or other stainless material as indicated by project specific plans and specifications.

Created: 09/30/14
Revised: 01/03/19

WATER MAIN CASING APPURTENANCES

W-22